

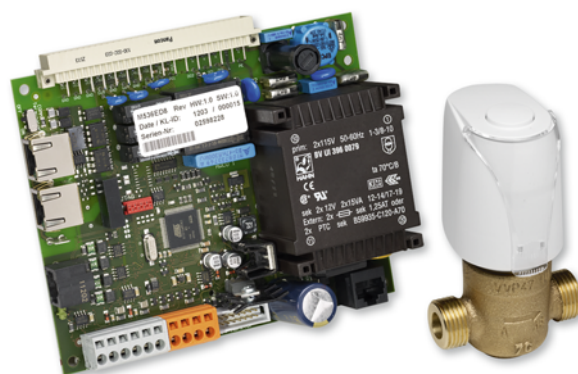

# Single room control system

## FSL-CONTROL II



Read the instructions prior to performing any task!

**TROX GmbH**

Heinrich-Trox-Platz

47504 Neukirchen-Vluyn

Germany

Phone: +49 (0) 2845 2020

Fax: +49 2845 202-265

E-mail: [trox@trox.de](mailto:trox@trox.de)

Internet: <http://www.troxtechnik.com>

A00000046303, 4, GB/en

04/2017

© TROX GmbH 2017

## General information

### About this manual

This manual enables personnel to correctly install and configure FSL-CONTROL II for the control of TROX decentralised ventilation units.

This manual is intended for use by network administrators, properly trained persons, and qualified electricians or air conditioning technicians.

It is essential that these individuals read and fully understand this manual before starting any work. The basic prerequisite for safe working is to comply with the safety notes and all instructions in this manual.

The local regulations for health and safety at work and the general safety regulations for the area of application of the ventilation unit also apply.

This manual must be given to the system owner when handing over the system. The system owner must include the manual with the system documentation. The manual must be kept in a place that is accessible at all times.

Illustrations in this manual are mainly for information and may differ from the actual design.

### Other applicable documentation

- Operating and installation manual for the decentralised ventilation unit
- Project-specific documents (if any)

### Copyright

This document, including all illustrations, is protected by copyright and pertains only to the corresponding product.

Any use without our consent may be an infringement of copyright, and the violator will be held liable for any damage.

This applies in particular to:

- Publishing content
- Copying content
- Translating content
- Microcopying content
- Saving content to electronic systems and editing it

### TROX Technical Service

To ensure that your request is processed as quickly as possible, please keep the following information ready:

- Product name
- TROX order number
- Delivery date
- Brief description of the fault

Online	<a href="http://www.troxtechnik.com">www.troxtechnik.com</a>
Phone	+49 2845 202-400

### Limitation of liability

The information in this manual has been compiled with reference to the applicable standards and guidelines, the state of the art, and our expertise and experience of many years.

The manufacturer does not accept any liability for damages resulting from:

- Non-compliance with this manual
- Incorrect use
- Operation or handling by untrained individuals
- Unauthorised modifications
- Technical changes
- Use of non-approved replacement parts

The actual scope of delivery may differ from the information in this manual for bespoke constructions, additional order options or as a result of recent technical changes.

The obligations agreed in the order, the general terms and conditions, the manufacturer's terms of delivery, and the legal regulations in effect at the time the contract is signed shall apply.

We reserve the right to make technical changes.

### Defects liability

For details regarding defects liability please refer to Section VI, Warranty Claims, of the Delivery and Payment Terms of TROX GmbH.

The Delivery and Payment Terms of TROX GmbH are available at [www.troxtechnik.com](http://www.troxtechnik.com).

<b>1</b>	<b>Safety</b> .....	<b>5</b>
1.1	Symbols used in this manual.....	5
1.2	Correct use.....	5
1.3	Safety signs.....	5
1.4	Electric shock hazard.....	6
1.5	Qualified staff.....	6
<b>2</b>	<b>Making electrical connections</b> .....	<b>7</b>
2.1	Wiring.....	7
2.1.1	Stand-alone operation.....	8
2.1.2	Integration with a central BMS.....	11
2.2	FSL-CONTROL II communication.....	12
2.2.1	Several controllers in a control zone.....	12
2.2.2	Network with several control zones.....	13
<b>3</b>	<b>Control of ventilation units</b> .....	<b>16</b>
3.1	FSL-CONTROL II.....	16
3.1.1	Control components.....	16
3.1.2	Functional description.....	16
3.2	FSL-CONNECT software .....	22
3.2.1	Starting screen.....	23
3.2.2	Setting control temperatures and operating times (commissioning wizard, or 'assistant').....	24
3.2.3	Diagnosis.....	30
3.2.4	Basic settings.....	32
3.2.5	Installing and connecting FSL-CONTROL II.....	33
<b>4</b>	<b>Control panel settings</b> .....	<b>35</b>
4.1	Analogue control panel.....	35
4.2	Digital control panel .....	36
<b>5</b>	<b>Configuring interfaces to the central BMS</b> ....	<b>37</b>
5.1	List of data points.....	37
5.2	BACnet MS/TP interface.....	53
5.3	Modbus RTU interface.....	61
<b>6</b>	<b>Index</b> .....	<b>72</b>

# 1 Safety

## 1.1 Symbols used in this manual

### Safety notes

Symbols are used in this manual to alert readers to areas of potential hazard. Signal words express the degree of the hazard.

Comply with all safety instructions and proceed carefully to avoid accidents, injuries and damage to property.

#### **DANGER!**

Imminently hazardous situation which, if not avoided, will result in death or serious injury.

#### **WARNING!**

Potentially hazardous situation which, if not avoided, may result in death or serious injury.

#### **CAUTION!**

Potentially hazardous situation which, if not avoided, may result in minor or moderate injury.

#### **NOTICE!**

Potentially hazardous situation which, if not avoided, may result in property damage.

#### **ENVIRONMENT!**

Environmental pollution hazard.

### Safety notes as part of instructions

Safety notes may refer to individual instructions. In this case, safety notes will be included in the instructions and hence facilitate following the instructions. The above listed signal words will be used.

Example:

1. ▶ Untighten the screw.

2. ▶

#### **CAUTION!**

**Danger of finger entrapment when closing the lid.**

Be careful when closing the lid.

3. ▶ Tighten the screw.





### Tips and recommendations



*Useful tips and recommendations as well as information for efficient and fault-free operation.*

### Additional markers

In order to highlight instructions, results, lists, references and other elements, the following markers are used in this manual:

Marker	Explanation
 1., 2., 3. ...	Step-by-step instructions
	Results of actions
	References to sections in this manual and to other applicable documents
	Lists without a defined sequence
[Switch]	Operating elements (e.g. push buttons, switches), display elements (e.g. LEDs)
'Display'	Screen elements (e.g. buttons or menus)

## 1.2 Correct use

The FSL-CONTROL II controller is designed exclusively for the control of TROX decentralised ventilation units.

Correct use also involves complying with all the information provided in this manual.

Any use that goes beyond the correct use or any different use of the unit is regarded as incorrect use.

## 1.3 Safety signs

The following symbols and signs are found on the unit. They apply to the very location where they are found.

### Electrical voltage



## Qualified staff

Hazardous electrical voltage that is present in the ventilation unit. Only skilled qualified electricians are allowed to work on parts of the ventilation unit marked with this symbol. Such work must be carried out only by skilled qualified electricians or the technical service.

### Controls access panel



Only skilled qualified electricians are allowed to open the controls access panel. Ensure that no voltage is present on any mains circuit before you open the cover to access the terminal connections.

### Skilled qualified electrician

Skilled qualified electricians are individuals who have sufficient professional or technical training, knowledge and actual experience to enable them to work on electrical systems, understand any potential hazards related to the work under consideration, and recognise and avoid any risks involved.

Any work has to be carried out by individuals who can be expected to carry out their assigned duties reliably. Individuals whose reaction time is delayed due to alcohol, drugs or other medication must not carry out any work.

## 1.4 Electric shock hazard

### Electric current

 **DANGER!**

**Danger of death due to electric current!**

Danger of electric shock! Do not touch any live components! Damaged insulation or damaged parts are a life threatening hazard.

- Only a skilled qualified electrician must work on the electrical systems.
- If the insulation is damaged, disconnect the power supply immediately and have the insulation repaired.
- Switch off the power supply before you carry out maintenance or cleaning.
- Ensure that live parts do not come into contact with moisture. Moisture can cause a short circuit.

## 1.5 Qualified staff

### Qualification

The work described in this manual has to be carried out by individuals with the qualification, training, knowledge and experience described below:

#### Network administrator

Network administrators design, install, configure and maintain the IT infrastructure in companies or organisations.

## 2 Making electrical connections

### DANGER!

**Electric shock hazard! Electrical equipment carries a dangerous electrical voltage!**

- Only skilled qualified electricians are allowed to work on the electrical system and to connect the unit to the mains.
- Disconnect the cable from the mains (all phases) and secure the unit against inadvertently being switched on again.
- Ensure that no voltage is present.
- Carry out assembly or connection jobs only as long as no voltage is present.

### Notes on the electrical installation

Any cables must be designed for the supply voltage for which they will be used. The length and cross section as well as any contact resistance may increase voltage losses. The power rating of each unit must also be considered. A skilled qualified electrician has to select the correct cable types and sizes. This job must only be carried out by specialist electrical companies.

- For the electrical connection comply with any applicable regulations and follow the code of good practice. Be sure to comply with the applicable VDE guidelines and local regulations.
- The connection data can be found on the rating plate or in the wiring diagrams.
- Protect any connections from physical damage.
- Lead cables through the cable glands on the ventilation unit.
- If any maintenance jobs have to be carried out, the unit first has to be de-energised (all phases). No voltage must be present. Separators can be used (e.g. fuses or RCBOs), minimum distance between contacts: 3 mm.
- For units without integral controls from TROX follow the instructions of the controls provider.

### Notes on control panels

Select an installation location where the control panel is not affected by disturbances. Avoid solar gain and draughts.

Seal the end of the conduit in the junction box as otherwise a draught could occur in the conduit and affect the measurement results.

## 2.1 Wiring

### Personnel:

- Skilled qualified electrician
- ▶ Connect the ventilation unit according to the wiring diagram.
  - Stand-alone operation ☞ 8
  - Integration with the central BMS ☞ 11

## 2.1.1 Stand-alone operation

### Wiring diagram, unit with digital control panel

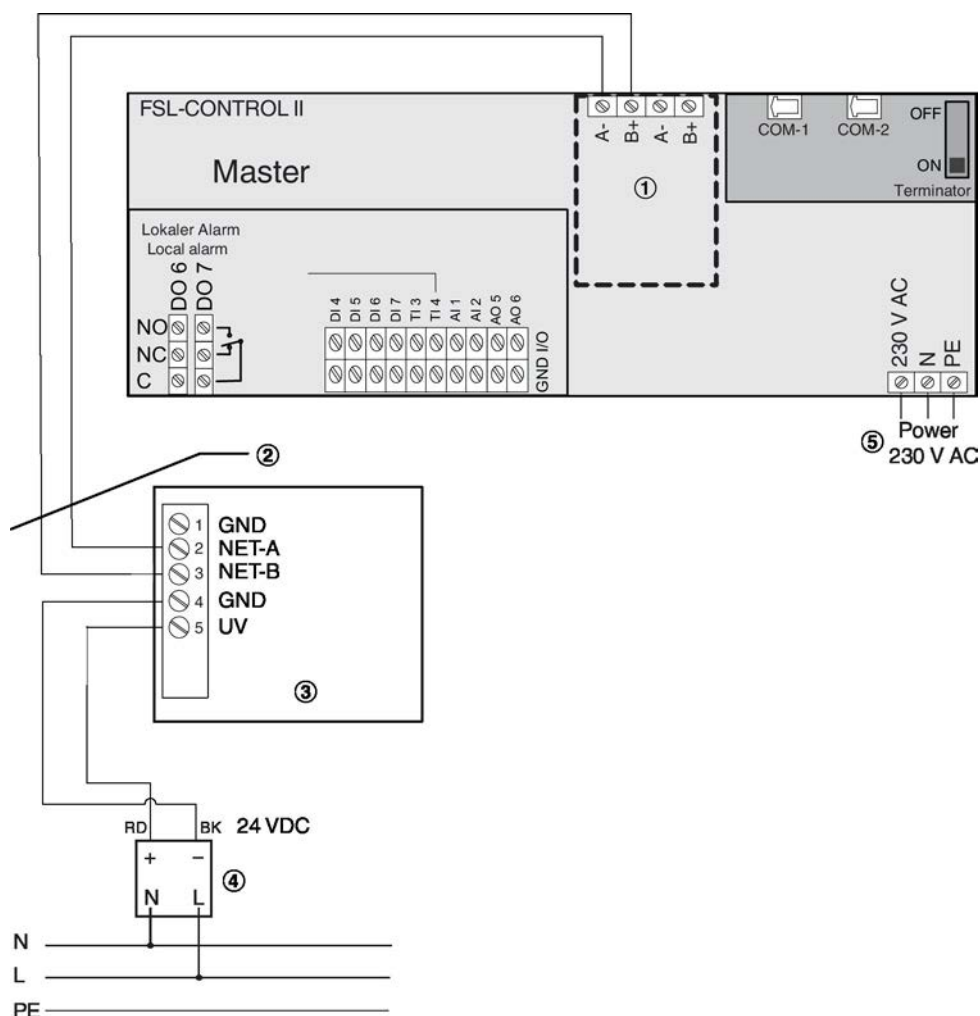

Fig. 1: Wiring diagram, stand-alone operation (without central BMS)

- ① LonWorks (FTT10) interface,  $\leq 14$
- ② JY(St)Y  $2 \times 2 \times 0.8$ , 10 m max. (use only twisted pair for LON-A and LON-B)
- ③ Digital control panel
- ④ Power supply unit, 24 V DC (optional or to be provided by others)
- ⑤ Connecting cable, e.g. Ölflex Classic 100 3G 0.75 or equivalent (by others)

#### Important note:

The digital control panel is a dedicated device to be used with the ventilation unit (master). Both carry the same serial number, which is found on the rating plate (ventilation unit) or on the packaging (control panel).

Use any control panel only for a ventilation unit with the same serial number.



## Digital control panel

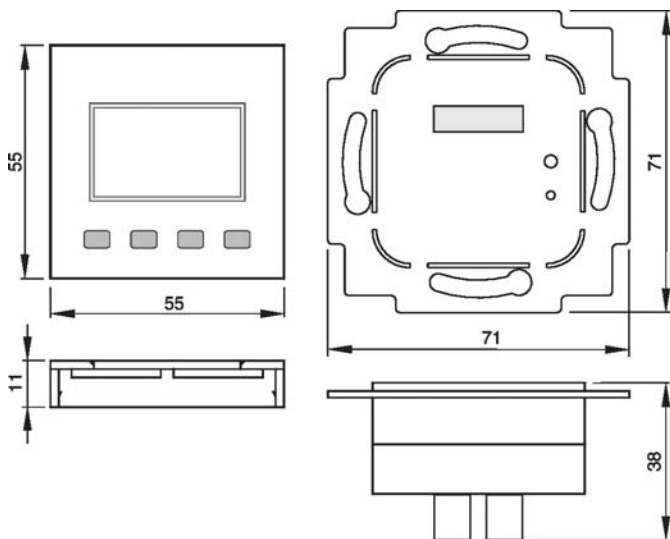

Fig. 2: Dimensions

Note: The overall dimensions depend on the frame that has been selected for the switch.

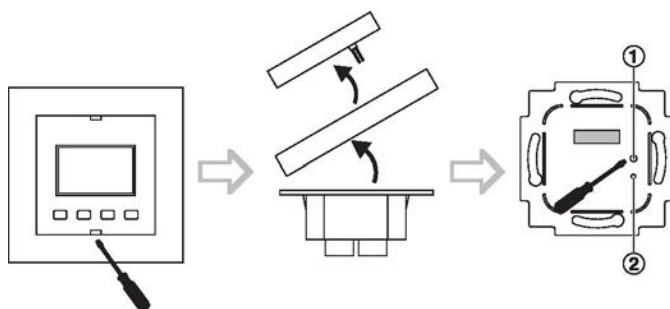

Fig. 3

- 1 Service push button
- 2 Service LED

## Notes on installation

The control panel is suitable for installation on a junction box. You can connect the bus cable to the control panel with a screw terminal. For pre-wiring you can remove the screw terminal from the panel.

We recommend using deep junction boxes as they provide more space for cables.

Attach the LON interface card to the screws (by others) in the junction box; max. torque for the screws is 0.8 Nm. Place the mounting ring of the LON interface card flat on the face of the wall; do not cover it with paint or wallpaper.

## Technical data

Supply voltage	15...24 V= (±10%) or 24 V~ (±10%)
Power consumption	1.3 W / 1.5 VA
Interface	FTT, free topology
Measuring range	0...+50 °C
Accuracy (21 °C)	±0.5 K
Response time	Time constant $t_{63}$ 15 minutes
Screw terminals	1.5 mm <sup>2</sup> max.
Protection level	IP 30 to EN 60529
Ambient temperature	0...50 °C
Transport	-10...50 °C / max. 85% rh, no condensation

## Wiring diagram, unit with analogue control panel

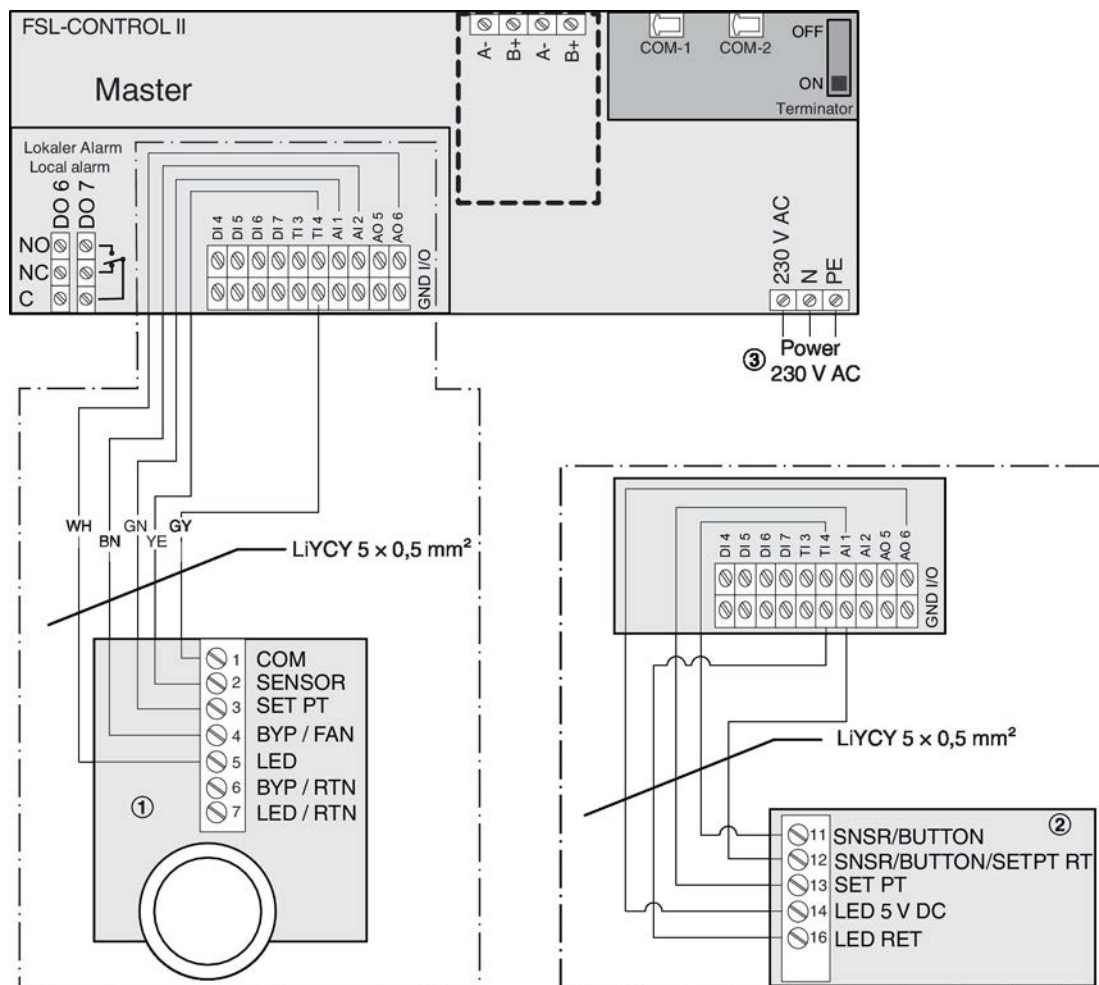

Fig. 4: Wiring diagram for analogue control panels

- ① Control panel with 0-1-2-3-AUTO selector switch
- ② Control panel without selector switch
- ③ Connecting cable, e.g. Ölflex Classic 100 3G 0.75 or equivalent (by others)

### 2.1.2 Integration with a central BMS

Wiring example for three interconnected FSL-CONTROL II controllers in a control zone

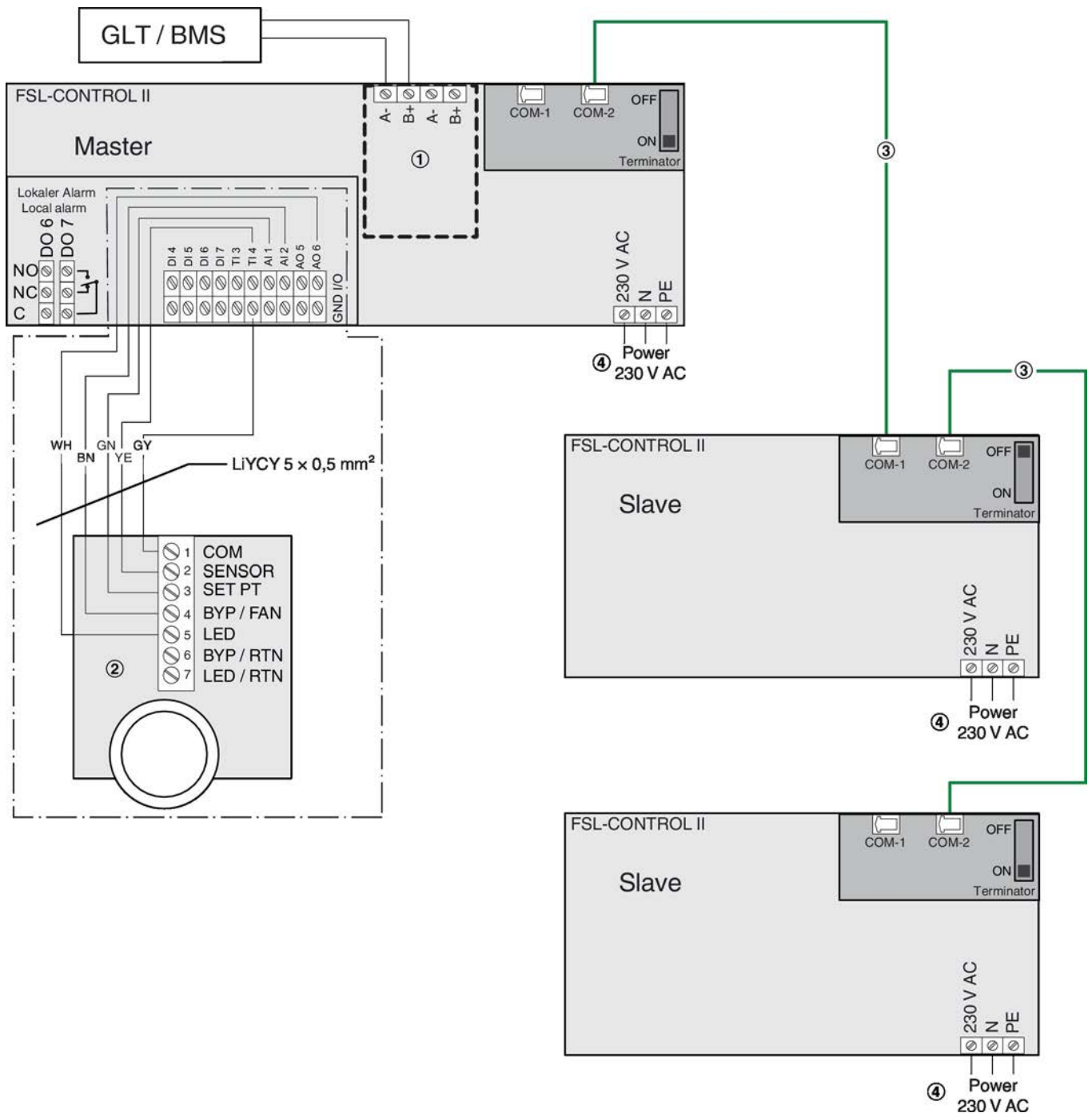

Fig. 5: Wiring diagram: Interconnected FSL-CONTROL II controllers

- ① LonWorks (FTT10) interface or BACnet MS/TP or Modbus RTU interface (optional) ⚡ 13
- ② Analogue control panel with or without selector switch (a digital control panel can be used only for stand-alone operation of the ventilation unit)
- ③ Patch cable (by others, at least cat. 5)
- ④ Connecting cable, e.g. Ölflex Classic 100 3G 0.75 or equivalent (by others)

## 2.2 FSL-CONTROL II communication

### 2.2.1 Several controllers in a control zone

Connect FSL-CONTROL II controllers (master-slave) within a control zone with a standard network cable (RJ45, to be provided by others).

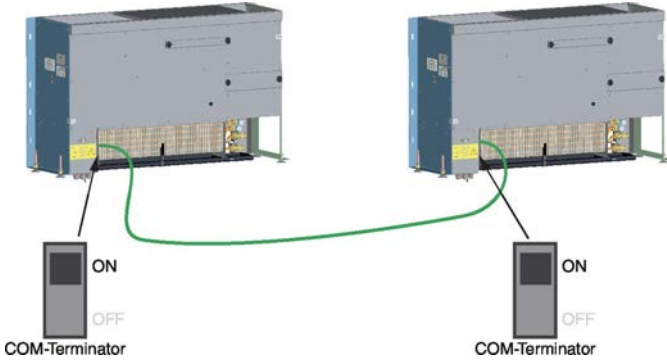

Fig. 6: FSL-CONTROL II communication of 2 units



Fig. 7: FSL-CONTROL II communication of 3 units

- Up to 15 FSL-CONTROL II controllers for a control zone (1 × master, 14 × slave)
- Up to 300 m network cable for each control zone
- Network cable type SF-UTP (braided and with foil), to ISO IEC 11801 (2002), as a patch cable with RJ45 plugs on both ends, or from a roll, at least cat. 5
- Activate terminal resistors on the first and last controllers on the communication cable

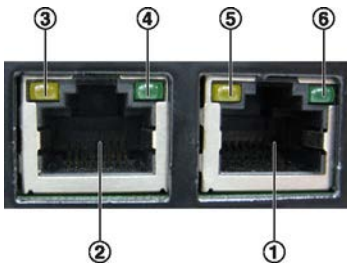

Fig. 8: Sockets and LEDs

- ① Port COM-1
- ② Port COM-2
- ③ LED for communication cable termination
- ④ Spare
- ⑤ LED - Data reception
- ⑥ LED - Heartbeat

### LEDs

Termination (yellow)

ON - Cable termination is enabled

OFF - Cable termination is disabled

Data reception (yellow)

ON (blinking) - Data reception in progress

OFF - No data reception

Heartbeat (green)

ON (blinking) - Normal controller operation

OFF - Device not ready

### Terminal resistor / termination

Fault-free data exchange between the controllers requires that both ends of the communication cable are terminated.

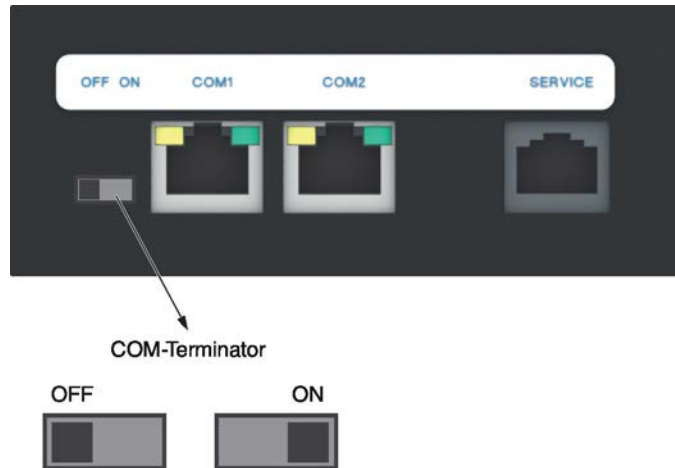

Fig. 9: COM terminal resistor

COM terminal resistor

OFF - Cable termination is disabled

ON - Cable termination is enabled

## 2.2.2 Network with several control zones

### Building a network

You may interconnect control zones by making use of a standard network such as LON FTT10, BACnet MS/TP or Modbus RTU. This requires a bus interface card to be connected to the FSL-CONTROL II master controller.

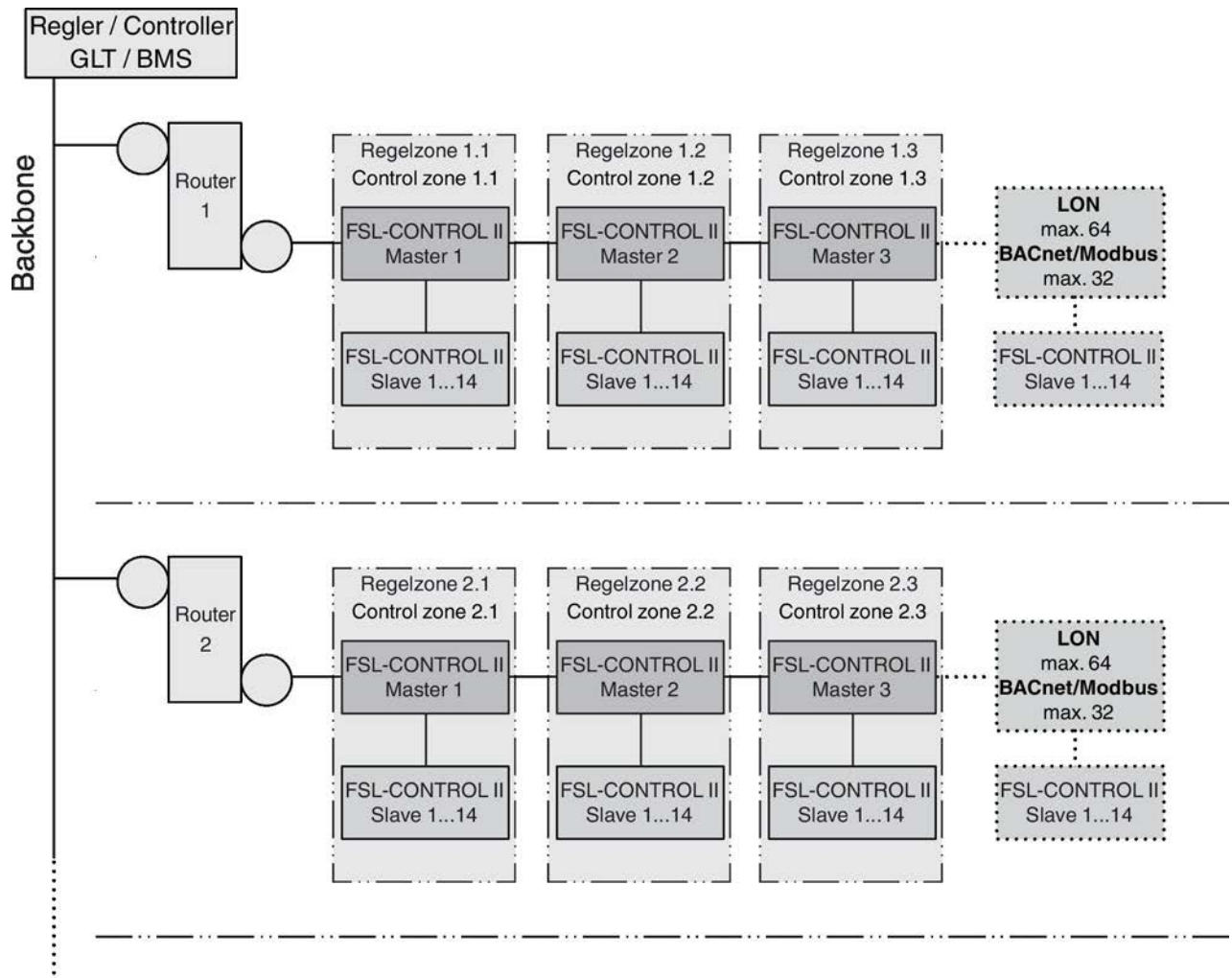

Fig. 10: FSL-CONTROL II, building a network



*If the master controller is integrated with a central BMS (by others), it acts as a slave within the bus network, but as a master within the FSL-CONTROL II system.*

## 2.2.2.1 Integration with a bus communication system (by others)

### 2.2.2.1.1 LonWorks interface card (FTT10)

#### Connecting the communication cables

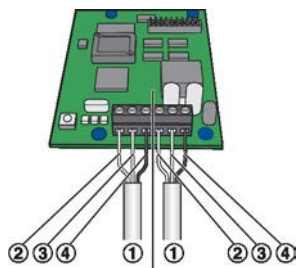

Fig. 11: Wiring the LonWorks interface card

- ① Bus
- ② LON A
- ③ LON B
- ④ SH (shield)

The LonWorks interface card has terminals for two bus cables of a LonWorks network. Depending on the network topology, controllers at the end of a chain may be connected to one bus, controllers at other positions in the chain may be connected to two buses.

1. ▶ Strip the insulation from the bus cable (at least two wires), insert the bare wires into the terminals and tighten the screws by hand.
2. ▶ Fix the data cables to the casing using the wire clamping bracket.
3. ▶ Connect the shield of shielded cables to the SH terminals.

Within a chain (channel) connect the shield only at one point to the earth. Earthing the shield at every controller will lead to voltage disturbances.

4. ▶ To avoid reflections at the end of a chain (channel), use a terminal resistor.

#### Recommended bus cables

Bus cables to TIA 568A, category 5

- Belden 8471 or 85102
- Cables to DOCSIS specification level IV
- JY(St)Y 2×2×0.8 (use only twisted pair for LON-A and LON-B)

## Commissioning

### Personnel:

- Network administrator

### Materials:

- Software, e.g. Echelon or LonMaker
- Application software, download from [www.troxtechnik.com](http://www.troxtechnik.com)

1. ▶ **Commissioning:** Press the service pin push button and download the application software for the LonWorks node.
2. ▶ **Binding:** Create the logical bindings for the network variables to be transferred by the LonWorks interface card (expansion module). As an alternative, use polling.
3. ▶ **Configuration:** If necessary, adjust the configuration.
4. ▶ Configure data points

### 2.2.2.1.2 BACnet MS/TP or Modbus RTU interface card

#### Connecting the bus cables

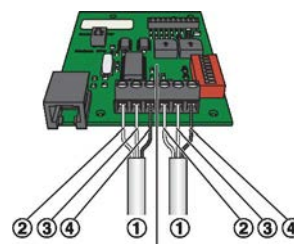

Fig. 12: Wiring the BACnet MS/TP or Modbus RTU interface card

- ① Bus cable
- ② B+ (EIA-485)
- ③ A- (EIA-485)
- ④ SH (shield)

The interface card has terminals for two cables of an EIA-485 network. A maximum of 32 units can be operated on one network segment.

- ▶ Strip the insulation from the bus cable (at least two wires), insert the bare wires into the terminals and tighten the screws by hand.

Make sure that the polarity of the conductor pairs is correct. Incorrect polarity will result in inverted data signals and hence communication errors.

- ▶ Fix the bus cables to the casing using the wire clamping bracket.
- ▶ Connect the shield of shielded cables to the SH terminals.

Within a chain (channel) connect the shield only at one point to the earth. Earthing the shield at every controller will lead to voltage disturbances.

- ▶ To avoid cable reflections, network segments must be terminated at both ends with 120 Ω bus terminal resistors. Alternatively, the terminal resistors can be enabled or disabled on the PCB.

**Recommended bus cables**

Twisted Pair, e.g. JY(St)Y 2 × 2 × 0.8 (use only twisted pair for B+ and A-)

**Hardware configuration**

Before you use a BACnet MS/TP or Modbus RTU interface card, you have to configure it to the actual application. To do so, use the switches on the interface card.

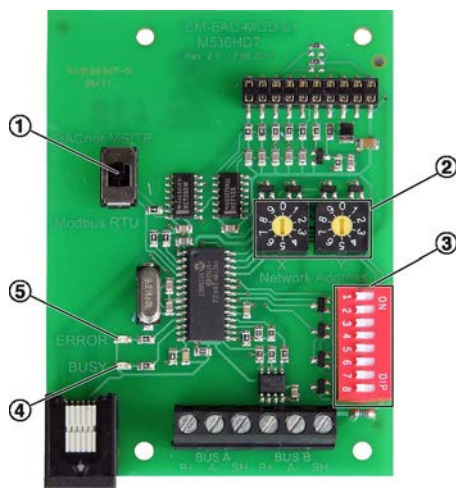

Fig. 13: BACnet MS/TP or Modbus RTU interface card

- ① Slide switch for setting the protocol type
- ② Rotary switch for setting the network address
- ③ DIP switch for setting the communications parameters
- ④ BUSY-LED (green): On = supply voltage OK, blinking = communication in progress
- ⑤ ERROR-LED (red): On = communication error

**Setting the protocol type**

Use the slide switch (Fig. 13/1) to set the BACnet MS/TP or Modbus RTU protocol.

**Setting the network address**

Use the two address code switches X and Y (Fig. 13/2) to set a network address (01 to 99). Address 00 is reserved for broadcast mode. A maximum of 32 controllers (network addresses) can be operated on one network segment. Each device requires a different network address.

**Transmission speed (EIA-485)**

BACnet	Modbus	S2	S3
9600 Bd	9600 Bd	Off	Off
19200 Bd	19200 Bd	On	Off
38400 Bd	38400 Bd	Off	On
76800 Bd	57600 Bd	On	On

**Parity**

Parity	S5	S6
None	Off	Off
None	On	Off
Odd	Off	On
Even	On	On

**Terminal resistor for EIA-485 network**

Terminal resistor	S8
Disabled	Off
Enabled	On

**Commissioning**

**Personnel:**

- Network administrator
  - ▶ Configuration of data points depending on protocol type
    - BACnet - Chapter 5.2 'BACnet MS/TP interface' on page 53
    - Modbus RTU - Chapter 5.3 'Modbus RTU interface' on page 61

## 3 Control of ventilation units

### 3.1 FSL-CONTROL II

#### System overview

FSL-CONTROL II is a dedicated single room control system for decentralised TROX ventilation systems.

FSL-CONTROL II can be used to combine the following control strategies:

- Room temperature or extract air temperature control
- Room air quality control (optional)

#### 3.1.1 Control components

The modular design of the hardware allows for adding optional equipment to expand the functions of FSL-CONTROL II.



Fig. 14: Main PCB, valve with thermoelectric actuator

#### Basic equipment

- Main PCB (control module)
- Heating and/or cooling valves including thermoelectric actuators and lockshields
- Supply air temperature sensor

#### Optional equipment

- Master PCB (room module)
  - Control panel including setpoint value adjuster and room temperature sensor
  - Outdoor air temperature sensor
  - VOC sensor
  - RTC module (real time clock)
  - LonWorks LON-FTT10 interface module
  - BACnet MS/TP interface card
  - Modbus RTU interface
- Valve actuators
- Pressure-independent control valve
- Modulating actuator for the bypass damper

#### **FSL-CONTROL II with several interconnected controllers**

A group of FSL-CONTROL II controllers must include at least 1 master. This group may include up to 14 slaves.

A plug-in communication cable (plug and play) is used for the communication between master and slave devices (at least cat. 5; the cable is not included in the supply package).

#### 3.1.2 Functional description

##### 3.1.2.1 General

FSL-CONTROL II is used to control various parameters for single rooms.



It is primarily used to control the room temperature, i.e. to maintain the set parameters and a comfortable room climate. With an air quality sensor (optional) it is possible to control the outdoor air flow rate based on the VOC value.

**i FSL-CONNECT software**

The FSL-CONNECT software for personal computers is used to configure the control parameters. The software is available for download from [www.troxtechnik.com](http://www.troxtechnik.com).

For more information on how to use the software see Chapter 3.2 'FSL-CONNECT software' on page 22.

**3.1.2.2 Room temperature control**

FSL-CONTROL II ensures that the comfort temperature range for each operating mode is maintained.

Cascade control ensures that the comfort temperature range is quickly achieved. The supply air temperature is controlled within the set range and with internal and external loads being accounted for. This is how the comfort requirements are met.

Room temperature control requires that the following values are measured:

- Room temperature, e.g. from an optional control panel or from the central BMS
- Outdoor air temperature, e.g. from the central BMS or from an optional temperature sensor in the outdoor air intake of the master unit
- Supply air temperature



Room temperature control works best when the room temperature is measured at a carefully selected point. The control panel is ideally installed about 1.5 m above the floor. Select an installation location where the control equipment is not affected by disturbances (e.g. solar gain or draughts). We recommend adjusting the flow temperature based on the outdoor temperature in heating and in cooling mode.

**Factory settings for room temperature (example)**

Operating mode	Room temperature setpoint values		
	Heating	Comfort range	Cooling
Occupied	< 21 °C	21...23 °C	> 23 °C
Standby	< 19 °C	19...25 °C	> 25 °C
Unoccupied	< 16 °C	16...28 °C	> 28 °C

To prevent the system from constantly changing between heating and cooling mode, the room temperature is controlled not to a fixed value, but within a comfort temperature range.

The effective room temperature setpoint value depends on:

- Heating mode (room temperature < room temperature limit for heating)
- Cooling mode (room temperature > room temperature limit for cooling)

In heating mode, the room temperature limit for heating is the room temperature setpoint to be achieved; in cooling mode, it is the room temperature limit for cooling. As soon as the room temperature has reached the comfort range, the supply air temperature is controlled to a previously set value (cascade basic value). If the room temperature setpoint value is changed, e.g. by your entering +2 K on a room control panel, both room temperature limits and hence the comfort temperature range are also changed by +2 K as a consequence. Recommended: Comfort temperature range 2 K.

**Factory settings for supply air temperature limits**

Operating mode	Supply air temperature limits	
	Heating	Cooling
Occupied	45 °C	18 °C
Standby	45 °C	16 °C
Unoccupied	45 °C	15 °C

For a comfortable room climate the supply air temperature in 'Occupied' mode should be at least 18 °C. In heating mode a comfortable room climate can be achieved with supply air temperatures of up to 45 °C.



These factory settings have been selected for their energy efficiency but can be changed for each project using the software.

**3.1.2.3 Bypass on the heat recovery unit**

The ventilation units are fitted with a bypass, which is controlled with an open/close actuator. The bypass is used in combination with the following functions: 'Night purge', 'Free heating' and 'Free cooling'.

Alternatively, a modulating actuator can be used. The volume flow to be heated by the heat recovery unit depends on the position of the bypass damper.

If, for example, the outdoor temperature is low, yet an internal space has to be cooled anyway, use of the cooling coil can be reduced to the minimum since only a small portion or even no portion of the air has to pass the heat recovery unit.

### 3.1.2.4 Fan stages

FSL-CONTROL II automatically selects the correct fan stage based on temperature control or air quality (optional). The fan stage can also be preset by the central BMS (by others) or from a control panel.

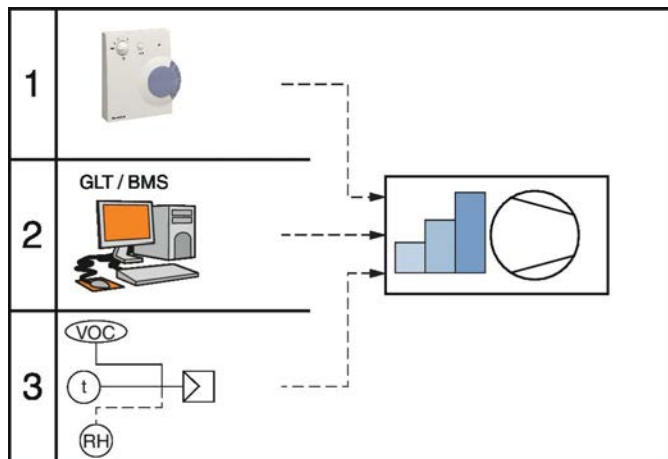

Fig. 15: Fan stages – priority

### 3.1.2.5 Air quality control

Air quality control means that the outdoor air flow rate is controlled based on the room air quality.

This type of control is only possible with an air quality sensor (optional equipment or by others). The optional VOC sensor captures various VOC emissions that are linked to the CO<sub>2</sub> content of the room air.

Air quality control is always active in 'Occupied' mode. It can additionally be activated in 'Standby' mode.

#### Air quality control – factory settings

VOC value [ppm]	Fan stage
> 800	1
> 1000	2
> 1300	3

#### Secondary air and outdoor air modes

FSL-CONTROL II ensures that units with secondary air function start in secondary air mode, which is energy efficient. As soon as the VOC value for fan stage 1 is exceeded, the unit automatically switches to outdoor air mode. Preset minimum periods of time ensure that not too many quick changes between the fan stages occur.

### 3.1.2.6 Operating modes

FSL-CONTROL II can be used for the following operating modes:

- Occupied
- Standby
- Unoccupied
- Boost

You can define different comfort temperature ranges for these operating modes.

You can define daily schedules and enter a start time for each operating mode. Using the optional real time clock (RTC) allows for defining 5 switching points per day. If no RTC is used, operating modes must be changed by the central BMS.

The comfort temperature range for all operating modes can be changed from the central BMS or using the control panel.

#### Occupied

The 'Occupied' mode is used for occupied rooms.

The following parameters can be set:

- Comfort temperature range
- Supply air temperature limits for heating/cooling

#### Standby

The 'Standby' mode is used to raise the temperature of a room before it is actually occupied.

The following parameters can be set:

- Comfort temperature range
- Supply air temperature limits for heating/cooling

#### Recommended:

- Use this operating mode in the early morning (e.g. from 6 to 7 am).
- Note the operating times of the heating and cooling systems.

#### Unoccupied

The 'Unoccupied' mode is used for unoccupied rooms.

The following parameters can be set:

- Comfort temperature range
- Supply air temperature limits for heating/cooling



**Unoccupied**

- This operating mode is used to protect the building; it is required for night purge.
- Air quality control is not possible with this operating mode.

**Boost**

The 'Boost' mode is used for the quick ventilation of rooms. This mode can be used, for example, to ventilate a classroom during breaks.

The following parameters can be set:

- Fan stage



The same comfort temperature range and supply air temperature limits as for the 'Occupied' mode are used.

You can enable 'Boost' mode using the room control panel.

**3.1.2.7 Functions**

The following functions of FSL-CONTROL II are factory set, based on the project-specific requirements. If necessary, the TROX Technical Service can change the factory settings at a later stage.

**3.1.2.7.1 Summer/winter compensation**

With summer compensation and winter compensation the comfort temperature range is automatically adjusted based on the outdoor air temperature.

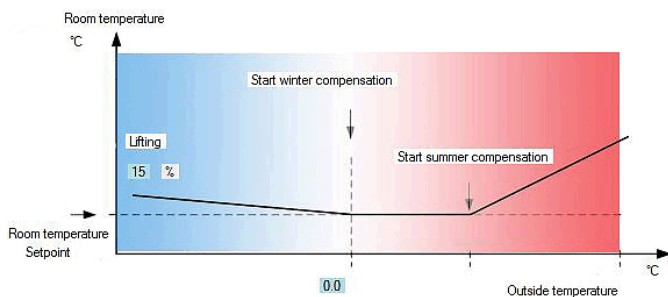

Fig. 16: Summer/winter compensation, example



**Recommended**

Winter compensation enabled, summer compensation disabled

**3.1.2.7.2 Minimum fan stages**

Setting minimum fan stages allows for enforced ventilation in all operating modes. The software can be used to select the minimum fan stage (0 to 5, if any).



**Recommended**

- Occupied – fan stage 1
- Standby – fan stage 0
- Unoccupied – fan stage 0

**3.1.2.7.3 Secondary air function**

If the room air quality is good, FSL-CONTROL II X-AIR-CONTROL switches to secondary air mode, which is more energy efficient. The shut-off dampers are closed and the supply air fan remains switched on.

The control system compares the room air quality limit value to the ACTUAL values measured by the VOC sensor and switches automatically between outdoor air and secondary air mode. The ventilation unit starts always in secondary air mode.

Secondary air mode is an option and only possible with air quality measurement (integral function or central BMS). The secondary air function is not available for all unit variants.



**Recommended**

Limit value: 600 ppm

**3.1.2.7.4 Frost protection**

**Room temperature frost protection**

FSL-CONTROL II provides frost protection for the controlled rooms. Room temperature frost protection depends on the measured room temperature. If the room temperature falls below a set limit, the frost protection function is activated. This means that the heating valve opens completely, the fans are switched off, and the dampers close. The module will not return to its previous configuration until the room temperature has increased to at least 1 K (can be configured) above the room temperature frost protection limit.



**Recommended**

Room temperature limit: 8 °C

**Supply air temperature frost protection**

To prevent the heat exchanger from freezing and becoming damaged as a consequence, the supply air temperature is measured immediately after the heat exchanger (when viewed in airflow direction). If the temperature falls below a set limit, the heating valve opens, the fans are switched off, and the damper closes. The control system will not return to its previous configuration until the room temperature has increased to at least 1 K (can be configured) above the temperature limit.



### Recommended

Supply air temperature limit: 8 °C

### Frost protection

If the outdoor temperature is  $\leq -20$  °C (can be configured) or if there is no outdoor temperature signal, the unit is switched off; this is to protect it if operating temperatures are too low.

### Heat recovery frost protection

If the outdoor temperature is very low, the airflow through the heat exchanger for heat recovery on the extract air side may become impaired or even impossible due to the freezing of the condensate; to prevent this from happening, the control system opens a motorised bypass damper. The bypass remains open until the outdoor air temperature has risen to at least 2 K (can be configured) above the limit.



### Recommended

Limit value: -6 °C

Frost protection of the heat exchanger for heat recovery can be signalled with an alarm relay on DO6/DO7.

As an alternative, the heat exchanger for heat recovery can be used as standard. After 180 minutes (configurable) the unit is set to secondary air operation for 20 minutes (configurable) such that ice build-up is avoided and the extract air duct is de-iced if necessary.

After the set time has elapsed, the previous operating mode is resumed.



*This function can be used all year round and helps to reduce the water heating energy required.*

*A condensate drain is required when you use this function.*

### 3.1.2.7.5 Start-up delay

If the outdoor air temperature is below 3 °C (can be configured), the start-up of the fans is delayed if one of the following is true:

- The ventilation unit is restarted
- The frost protection function ends
- The fan stage is changed from 0 to 1

Start-up delay means that the heating valve opens and the heating coil is preheated for 300 s (can be configured). After the preheating time has elapsed, the control system starts the operating mode valid for this time.

### 3.1.2.7.6 Free cooling

Free cooling means that outdoor air is supplied directly to the room, without passing through the heat exchanger for heat recovery.

Requirements:

- Room temperature > comfort temperature range
- Outdoor air temperature < comfort range upper limit
- $\Delta t$  Room temperature to outdoor temperature >5 K (can be configured) for at least 10 minutes
- The supply air temperature for the operating mode must not fall below the set limit

If the room temperature to outdoor air temperature difference falls below 1 K (can be configured) or if the room temperature reaches the comfort temperature range, free cooling is disabled. The unit resumes the original operating mode.



### Recommended

Select free cooling for the following operating modes:

- Unoccupied
- Standby
- Occupied

### 3.1.2.7.7 Free heating

Free heating means that outdoor air is supplied directly to the room, without passing through the heat exchanger for heat recovery.

Requirements:

- Room temperature < comfort temperature range
- Outdoor air temperature > comfort range lower limit
- $\Delta t$  Room temperature to outdoor temperature >2 K (can be configured) for at least 10 minutes
- The supply air temperature for the operating mode must not exceed the set temperature limit

If the outdoor air temperature to room air temperature difference falls below 1 K (can be configured) or if the room temperature reaches the comfort range, free heating is disabled.

**Recommended**

Select free heating for the following operating modes:

- Unoccupied
- Standby
- Occupied

**3.1.2.7.8 Night purge**

In the summer months (can be configured; factory setting: May to September), the night purge function allows for the building to be cooled during the nights, which is energy efficient. This function requires that the optional real time clock (RTC) is used. If no RTC is used, operating modes must be changed by the central BMS.

**Saving energy**

Night purge provides a high energy savings potential since rooms can be 'pre-cooled' at night without using a cooling coil.

**Recommended**

Highest fan stage

**3.1.2.7.9 Filter change**

The 'Filter change' function sends an alarm to the control panel if a filter change is required.

Analogue control panel - LED double blinking

Digital control panel -  symbol

You have to reset the number of operating hours after each filter change. To do so, either keep the occupancy push button on the room control panel pressed for at least 10 s or use the FSL-CONNECT software (  31).

**3.1.2.7.10 Enforced fan activation**

Fan activation is enforced by a signal sent to a digital input. Fresh air flow rate and exhaust flow rate can be configured separately.



Fume hoods or fume cupboards can extract high air volumes in classrooms and similar rooms. Enforced fan activation can help to achieve balanced volume flow rates.

**3.1.2.8 Interfaces**

FSL-CONTROL II masters provide 4 digital inputs and 3 digital outputs. These can be used for the following functions:

- Inputs
  - **Frost protection hardware:** Additional frost protection sensor, e.g. capillary tube sensor with a digital output, as an additional means of switching units safely off if there is a risk of freezing.
  - **Window contact:** As soon as a window is opened, the master and slave devices in the room (connected via a communication cable) will be switched off.
  - **Changeover function:** Allows for changing from heating to cooling and vice versa in 2-pipe heat exchangers.
  - **Fire protection:** Master and slave devices are switched off if a signal is received at the corresponding input.
  - **PIR:** 'Occupied' mode can be manually enabled.
- Outputs (all contacts can be configured as NO or NC contacts).
  - **Alarm relay:** Frost protection
  - **Activation relay:** Signal regarding a heating or cooling request in changeover operation.
  - **Analogue output:** Powerless

**Digital inputs**

Factory setting: not configured

**Digital outputs:**

Max. contact load of relays: 230 VAC, 2 A

## 3.2 FSL-CONNECT software

The FSL-CONNECT software can be used to adjust the preset control parameters. It can also be used for maintenance. The software is available for download from the TROX website. Using the software requires an activation code, which you will receive by e-mail once you have registered. Enter the licence code when you start the software for the very first time.

You need a connecting cable to connect a PC to FSL-CONTROL II.



Fig. 17: Adapter and connecting cable

- ① USB-RS485 adapter with driver software (replacement part no. M536ED7)
- ② Connecting cable with RJ45 and 9-pole DSUB socket (replacement part no. M516SM3)



For more information on how to connect the control system to a PC and on how to install the software see [Chapter 3.2.5 'Installing and connecting FSL-CONTROL II'](#) on page 33

### 3.2.1 Starting screen

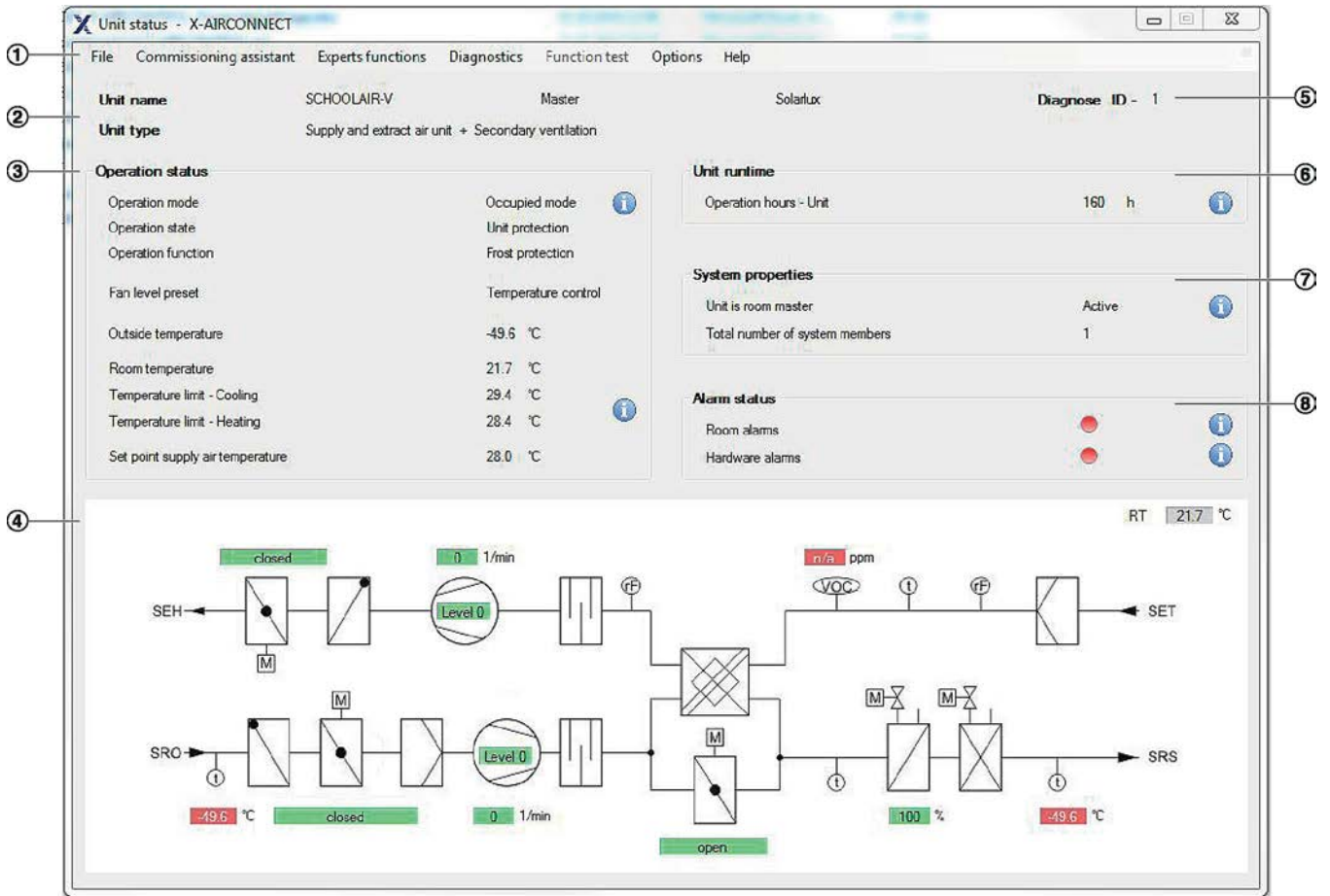

Fig. 18: FSL-CONNECT

- ① Main menu
- ② Unit name and unit type
- ③ Current operating modes and temperatures
- ④ Schematic illustration (example) with status displays
- ⑤ Diagnosis ID to identify the unit in a group of inter-connected units
- ⑥ No. of total operating hours
- ⑦ System properties
- ⑧ Alarm status

#### Symbols

Symbol	Meaning
	Shut-off damper with the damper blade position shown
	Fan including fan stage and speed
	Heating coil and valve setting (percentage)
	Filters

Symbol	Meaning
	Cooling coil and valve setting (percentage)
	Recuperative heat exchanger
	Non-return damper (depends on unit type)
	Sound attenuator
	Volume flow rate limiter (depends on unit type)

Symbol	Meaning
	Volume flow controller with Compact controller (depends on unit type)
	Temperature sensor
	Humidity sensor (optional)
	Air quality sensor (optional)
SEH	Single room exhaust air
SET	Single room extract air
SRO	Single room outdoor air
SRS	Single room supply air
SEC	Secondary air

Colour codes

green - Function OK

red - Function not OK

### 3.2.2 Setting control temperatures and operating times (commissioning wizard, or 'assistant')

To set control temperatures and operating times, go to the main menu and select *'Commissioning assistant'*.

On the *'Temperature control'* page you can set the control parameters for cooling (Fig. 19/1) and heating (Fig. 19/6). After setting the parameters, select *'Next'* to go to the *'Room Management'* page.



### 3.2.2.1 Control temperatures

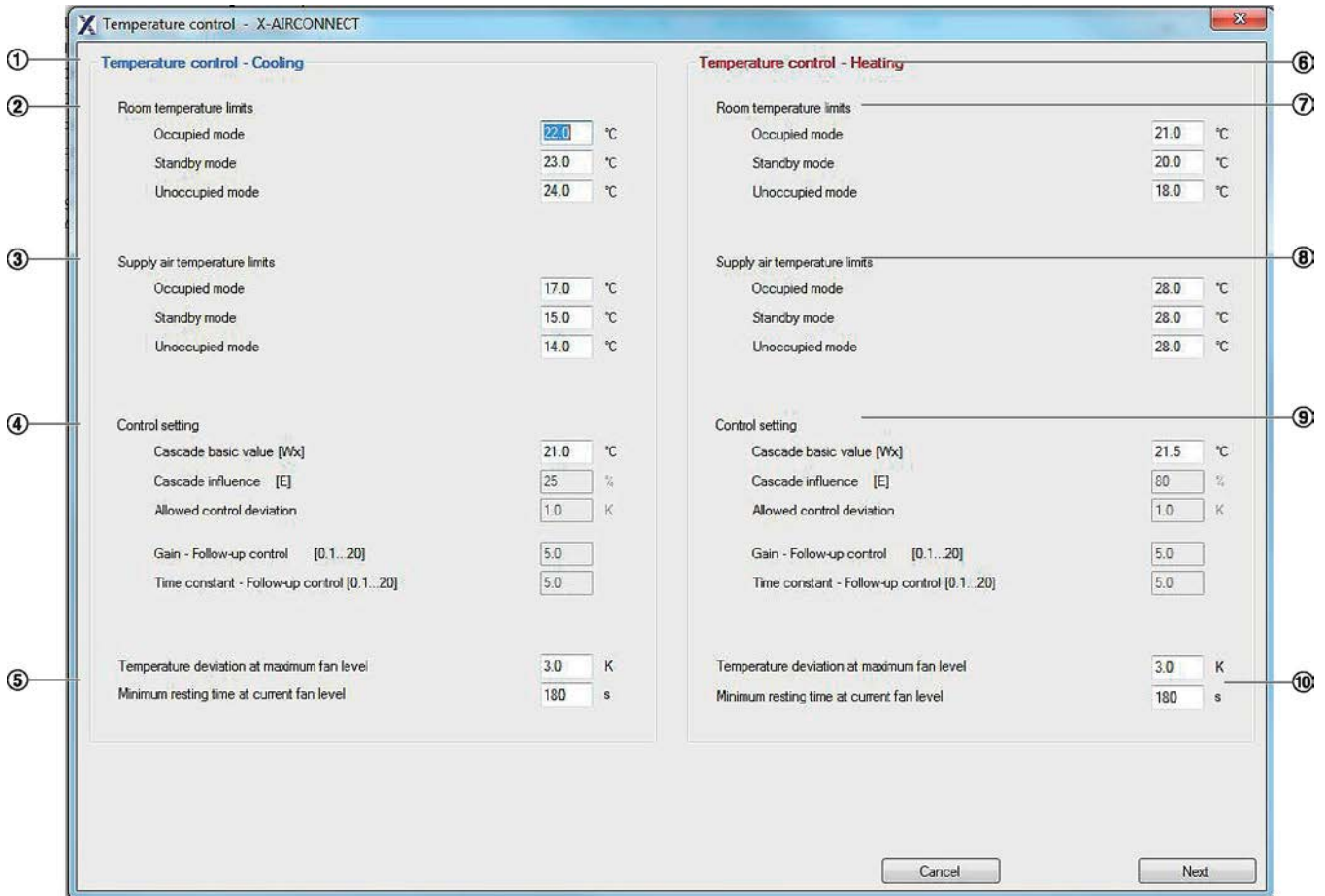

Fig. 19: Temperature control

#### 3.2.2.1.1 Cooling

##### Room temperature limits (Fig. 19/2)

In cooling mode the room temperature is cooled down to the comfort range upper limit for the operating mode. If the room temperature is above the comfort range, the unit starts to cool the room air. If the room temperature is within the comfort temperature range, the supply air is provided to the room with the set cascade basic value for cooling.



You can set the upper limit of the comfort range for each operating mode independently.

Recommended:

- Occupied: 23 °C
- Standby: 24 °C
- Unoccupied: 25 °C

##### Supply air temperature limits (Fig. 19/3)

For a comfortable room climate the supply air temperature in 'Occupied' mode should be at least 18 °C.



You can set the lower limit of the comfort range for each operating mode independently.

Recommended:

- Occupied: 18 °C
- Standby: 15 °C
- Unoccupied: 12 °C

##### Control parameters (Fig. 19/4)

**Cascade basic value** - This is the supply air temperature setpoint to be maintained when the room temperature reaches and remains within the comfort range; factory setting: 22 °C

Only the TROX Technical Service can change the following parameters:

- Cascade influence** - This parameter influences the calculation of the supply air setpoint temperature. The higher the cascade influence, the smaller the deviation of the supply air temperature from the cascade basic value; factory setting: 40 %
- Allowed control deviation** - Range for which the supply air temperature is not corrected; factory setting: 0.5 K
- Gain - Follow-up control** - The higher the 'Gain - Follow-up control' value, the larger the valve stroke change; factory setting: 4.0
- Time constant - Follow-up control** - The higher the 'Time constant - Follow-up control' value, the more often the valve stroke is adapted; valve setting: 5.0

### Fan stage (Fig. 19/5)

- Temperature deviation at maximum fan stage** - When the set  $T_{set}$  to  $T_{actual}$  deviation is reached, the fan is automatically set to the highest stage; factory setting: 3.0 K
- Minimum resting time at current fan stage** - Period of time for which the current fan stage remains set; factory setting: 180 s.

### 3.2.2.1.2 Heating

#### Room temperature limits (Fig. 19/7)

In heating mode the room temperature is heated to the comfort range lower limit for the operating mode. If the room temperature is below the comfort range, the unit starts to heat the room air. If the room temperature is within the comfort range, the supply air is provided to the room with the set cascade basic value for heating.



*You can set the lower limit of the comfort range for each operating mode independently.*

*Recommended:*

- Occupied: 21 °C
- Standby: 21 °C
- Unoccupied: 19 °C

#### Supply air temperature limits (Fig. 19/8)

For a comfortable room climate the supply air temperature should not exceed 45 °C.



*You can set the upper limit of the comfort range for each operating mode independently.*

*Recommended:*

- Occupied: 45 °C
- Standby: 45 °C
- Unoccupied: 45 °C

#### Control parameters (Fig. 19/9)

- Cascade basic value** - Cascade control setpoint value; factory setting: 22 °C
- Cascade influence** - Factory setting: 40 %
- Allowed control deviation** - Same as cooling
- Gain - Follow-up control** - Same as cooling
- Time constant - Follow-up control** - Same as cooling



*Only the TROX Technical Service can change grey parameters.*

#### Fan stage (Fig. 19/10)

- Temperature deviation at maximum fan stage** - When the set  $T_{set}$  to  $T_{actual}$  deviation is reached, the fan is automatically set to the highest stage; factory setting: 3.0 K
- Minimum resting time at current fan stage** - Period of time for which the current fan stage remains set; factory setting: 180 s.

### 3.2.2.2 Operating hours

To set operating times, select 'Commissioning assistant'.

On the 'Temperature control' page you can set the control parameters for cooling and heating, ↩ 24. After setting the control parameters select 'Next' to go to the 'Room Management' page.

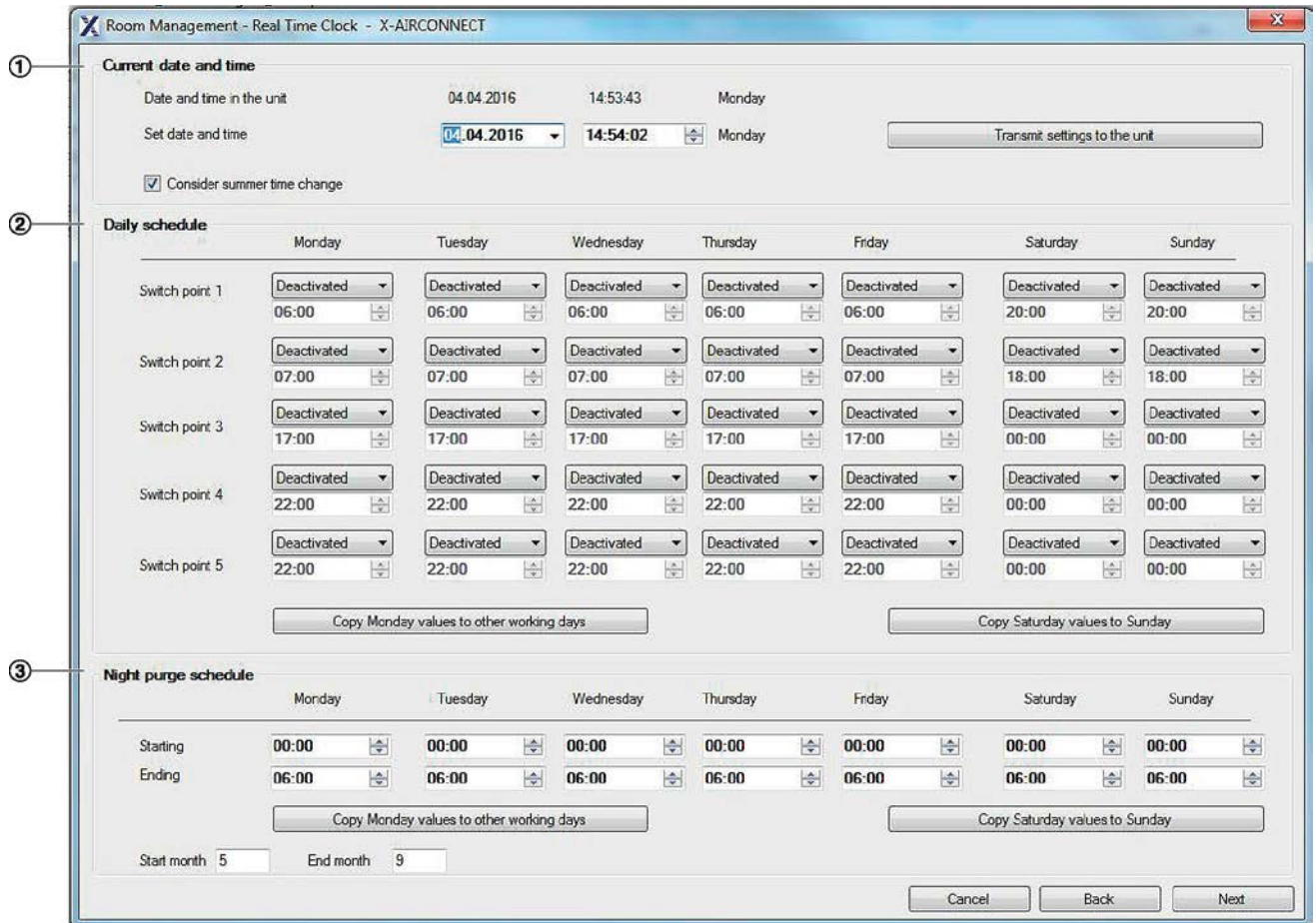

Fig. 20: Room management

#### 3.2.2.2.1 Date and time

Use the fields under 'Current date and time' to display and set operating dates and times for the unit. If you want to send any settings to the ventilation unit, select 'Transmit settings to the unit'.

#### 3.2.2.2.2 Daily schedule

Times when the operating mode should be changed can be set for each day. Using the optional real time clock (RTC) allows for defining 5 switching points per day.

Operating modes

- Occupied - The system runs with the preset parameters.
- Standby - Standby mode, which can be used to preheat a room for occupancy.
- Unoccupied - Frost protection for the building is enabled, night purge may be enabled.

- Boost - Used for short-time ventilation, e.g. during breaks; has to be configured using the software
- Disabled - This switching point is not used.

#### Example: office hours from 8:00 to 17:00

- 6:00 - Standby - 1 hour before work starts, the unit switches to [Standby]
- 7:00 - Occupied - 15 minutes before work starts, the unit switches to [Occupied]
- 12:00 - Boost - During breaks the unit switches to [Boost]
- 12:30 - Occupied - After a break the unit switches to [Occupied]
- 17:00 - Unoccupied - After a break the unit switches to [Unoccupied]

## Night purge

In the summer months (can be configured; factory setting: May to September), the night purge function allows for the building to be cooled during the nights, which is energy efficient. The room temperature will then have reached a comfortable level by the time the building is occupied. The night purge function must be initiated by a higher-level system (RTC, central BMS or DI); night purge is only possible in 'Unoccupied' mode. If the room temperature exceeds the cooling setpoint value and if the outdoor air temperature is at least 2 K (can be configured) below the cooling setpoint value, the heat recovery will be bypassed and the room will be ventilated by the fan (fan stage can be configured; factory setting: maximum fan speed).



### **Saving energy**

*Night purge provides a high energy savings potential since rooms can be 'pre-cooled' at night without using a cooling unit.*

### 3.2.2.2.3 Transferring configuration parameters

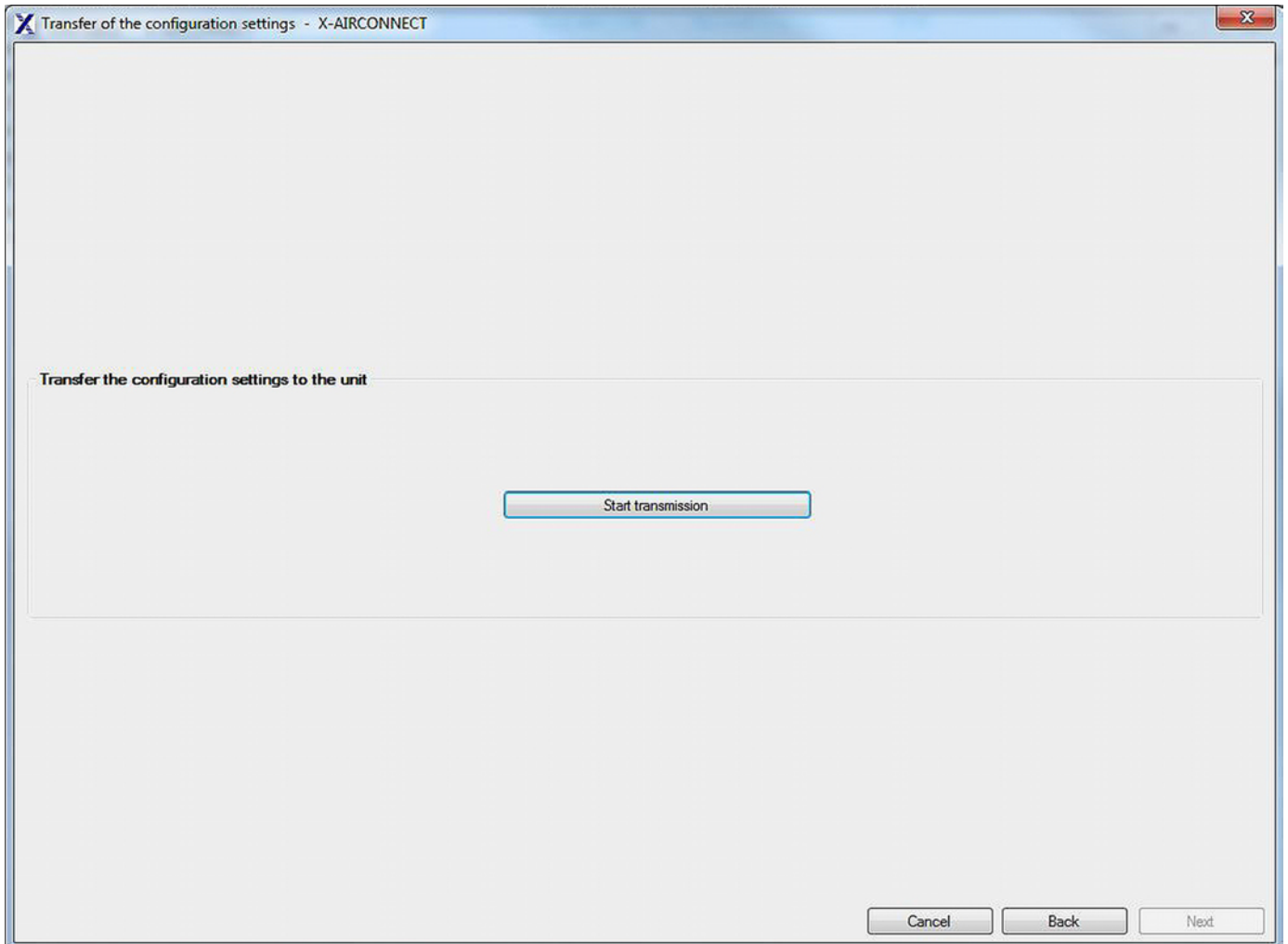

Fig. 21: Transferring configuration parameters

After setting control temperatures ↗ Chapter 3.2.2.1 'Control temperatures' on page 25 and operating times ↗ Chapter 3.2.2.2 'Operating hours' on page 27, select 'Start transmission' to send the parameters to the ventilation unit.

After the parameters have been sent, the ventilation unit has to be restarted. To restart the unit, go to the 'Expert functions' menu and select 'Restart unit'.



#### **Documentation of configuration settings**

You may save the configuration settings as PDF. To do so, go the 'File' menu and select 'Save configuration settings in PDF format'.

### 3.2.3 Diagnosis

To open the diagnosis functions, go to the main menu and select 'Diagnostics'.

**Detected components**

	Hardware - Name	Hardware - Version	Software - Name	Software - Version	Serial number
Basic unit	AWCU01-01	1.1	X-AC AWCU01	2.0	4278190407
Port COM 5	SEM-AWIO	1.1	X-AC SEM-AWIO	1.0	
Expansion slot 1	.....	.....	.....	.....	
Port COM 1	.....	.....	.....	.....	
Unit communication				2.0	
PC-Software			X-AIRCONNECT	3.0.0.0	

**Miscellaneous**

User ID	1	Total operating time	160 h	<input type="button" value="Reset the total operating time"/>
User group :	Diagnostics	Last configuration change	22.03.2016	via user id 20036

**Control concepts**

Room temperature control	Active	VOC control	Active		
Extract air temperature control	Inactive	Humidity control	Inactive	Usage humidity sensor	Inactive

Fig. 22: Diagnosis

The 'Diagnostics' page allows you to use other functions by selecting the corresponding tabs.

### 3.2.3.1 Resetting the filter operating hours counter

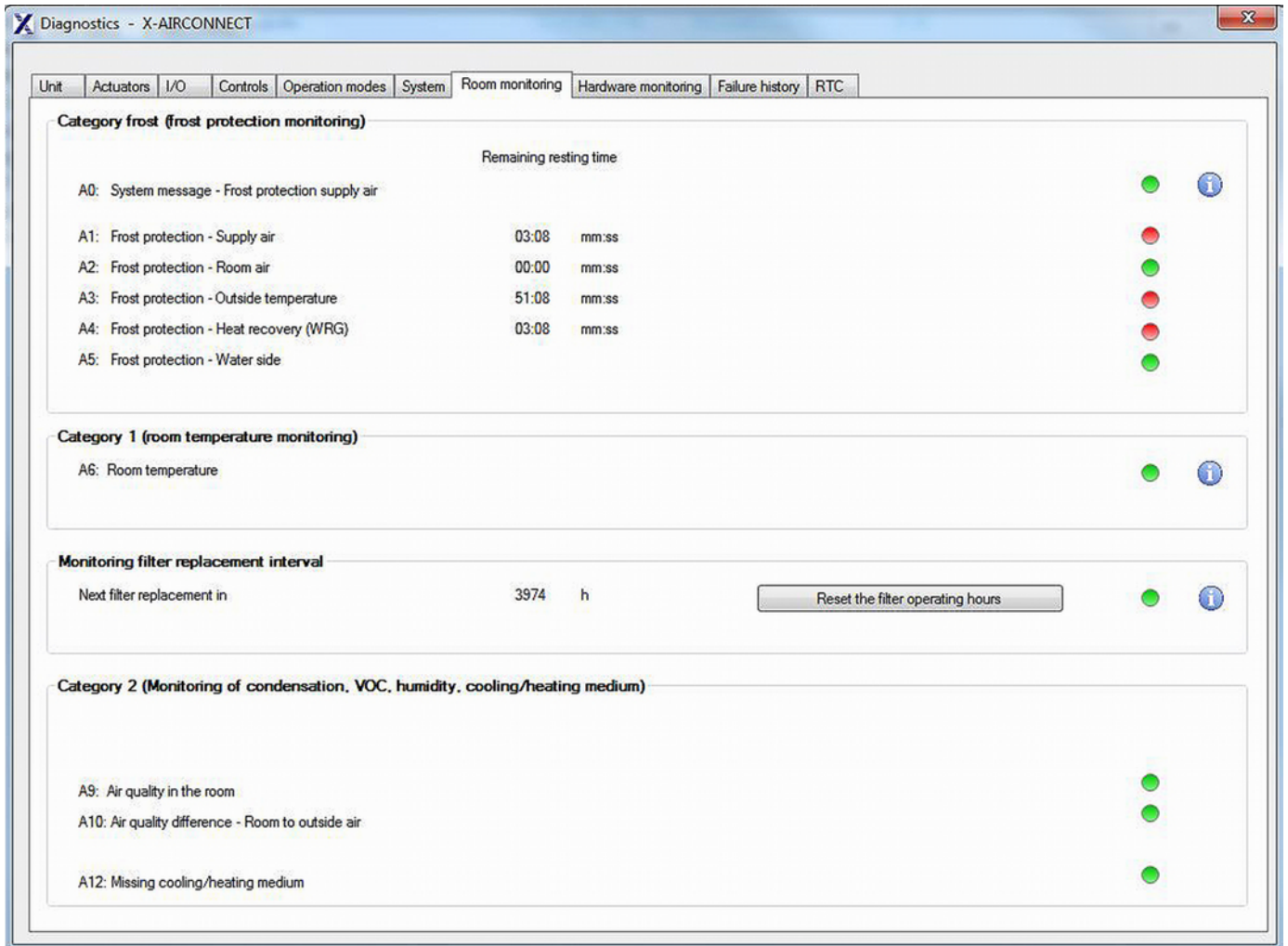

Fig. 23: Diagnosis - Room monitoring

After a filter on the ventilation unit has been changed, the filter operating hours counter should be reset. To do so, go to the 'Diagnostics' menu and select the 'Room monitoring' tab; on the page that opens select 'Reset filter operating hours'.

### 3.2.4 Basic settings

#### Changing the language

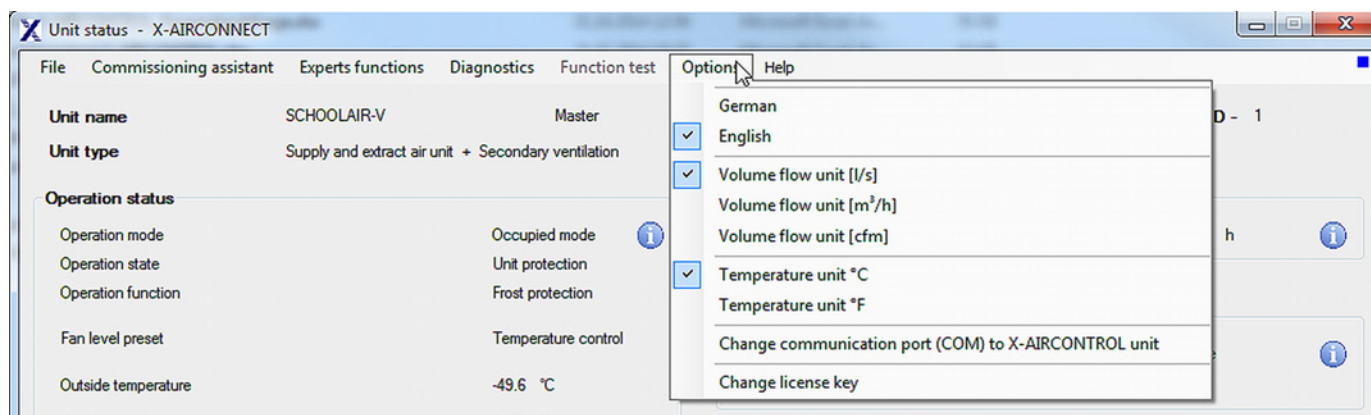

Fig. 24: FSL-CONNECT main menu, 'Options'

To set the dialogue language go to the 'Options' menu and select 'German' or 'English'.

#### Changing units of measure

To set or change the unit of measure for volume flow rate or temperature, go to the 'Options' menu and select the unit of measure you want to set or change.

#### Changing the licence key

To enter the licence key, go to the 'Options' menu and select 'Change licence key'. Then enter the licence key and accept it.



### 3.2.5 Installing and connecting FSL-CONTROL II

#### Step 1: Download the FSL-CONNECT software

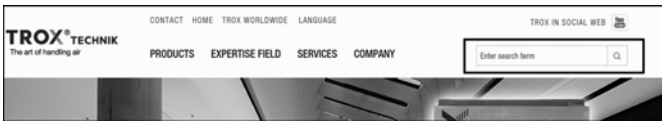

1. On the TROX website <http://www.trox.de> find the search field, enter 'FSL-CONTROL' and open the respective product page.

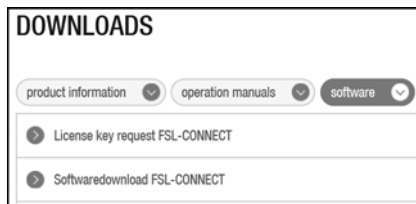

2. On the product page select 'DOWNLOADS -> Software -> Configuration software FSL-CONNECT'.

**TROX FSL-CONNECT - SOFTWAREDOWNLOAD**

You will receive an Email including a link to the download area after sending the form.

Address:  
**Company:**   
**Name:**   
 First name:   
 Department:   
 Street:   
 ZipCode:   
 City:   
 Country:   
 EMail:   
 Telephone:   
 Fax:

Note: The fields shown in bold must be completed.

3. Enter your contact data into the form and click 'Send'.  
 ⇒ You will then receive an e-mail with the link to download the software.

 If you do not receive an e-mail with the link, check your spam filter settings.

#### Step 2: Requesting the licence key

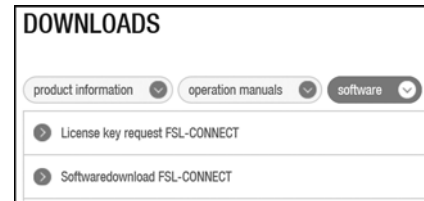

1. Select 'DOWNLOADS -> Software -> Licence key request FSL-CONNECT'.

**TROX FSL-CONNECT - LICENCE KEY REQUEST**

TROX FSL-CONNECT - License Key request

Address:  
**Company:**   
**Name:**   
 First name:   
 Department.:   
 Street:   
 ZipCode:   
 City:   
 Country:   
 Email:   
 Telephone:   
 Fax:   
 TROX Commission-number of FSL-CONNECT order:

Remarks:

Note: The fields shown in bold must be completed.

2. Enter your contact data into the form and click 'Send'.  
 ⇒ You will then receive an e-mail with your personal activation code.

 If you do not receive an e-mail with the link, check your spam filter settings.

#### Step 3: Installing the software

1. Unzip the ZIP archive you have just downloaded and install the software.

## Step 4: Connecting your personal computer to FSL-CONTROL II – Starting the software



1. ▶ Connect the connecting cable to the USB-RS485 plug, and plug the adapter into the USB port of your personal computer or notebook.



①



- ① Service socket
2. ▶ Plug the communication cable into the service socket ① of the FSL-CONTROL II controller.
3. ▶ Start the FSL-CONNECT software and enter the licence key (only required when you start the software for the very first time).

## 4 Control panel settings

### 4.1 Analogue control panel

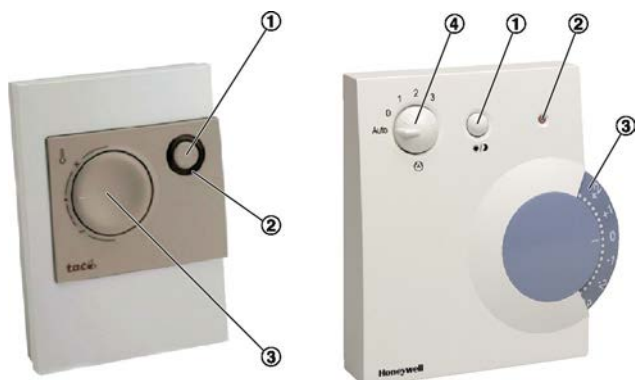

Fig. 25: Control panels

- ① Occupancy push button
- ② LED
- ③ Setpoint value adjuster
- ④ Fan stage selector

Function	Description	LED
Occupied/ Unoccupied <sup>1</sup>	If you want to change the operating mode from 'Occupied' to 'Standby' or vice versa, press the Occupancy push button briefly.  This allows you, for example, to manually switch to 'Standby' mode when the room is not occupied.  Start-up delay: 1 to 2 minutes in summer, 6 to 7 minutes in winter.	Standby: LED off Occupied: LED on
Boost	If you want to activate or deactivate rapid ventilation of the room, keep the Occupancy push button pressed for some time.	LED blinks slowly
Overtime <sup>1</sup>	If you want to manually switch on the Overtime function while the system is in 'Standby' or 'Unoccupied' mode, press the Occupancy push button briefly.  This allows you to set the ventilation unit to 'Occupied' mode for a previously set period of time if, for example, overtime is required after the regular office hours.  The overtime period can be configured. After the set period the unit resumes the previous operating mode (RTC/central BMS).	Standby: LED off Overtime: LED on
Filter change	Double blinking of the LED indicates that a filter change is required (the number of operating hours can be configured; factory setting: after 2500 h).  To reset the number of operating hours, either keep the occupancy push button pressed for at least 10 s or use the FSL-CONNECT software.	LED double blinking  This function overrides all other LED signals.
Alarm	Frost alarm and hardware alarm.	LED blinks rapidly

1) The room control panel is factory set to either the 'Occupied/Unoccupied' function or the 'Overtime' function. If you need to change this setting, contact the TROX Technical Service.

## 4.2 Digital control panel

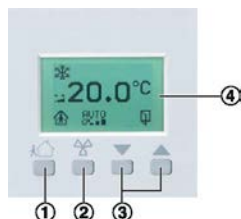

Fig. 26: Digital control panel

Push button Function	Settings	Display ④	Description
① Operating mode	Occupied		The 'Occupied' mode is used for occupied rooms.
	Unoccupied		The 'Unoccupied' mode is used for unoccupied rooms.
	Boost		'Boost' is used to increase ventilation, e.g. during breaks.
② Ventilation	Automatic		Automatically controlled ventilation.
	Off		Ventilation off.
	Stage 1		Manual ventilation control at the lowest level.
	Stage 2		Manual ventilation control at a medium level.
	Stage 3		Manual ventilation control at the highest level.
③ Temperature	▲		Used to increase the setpoint temperature.
	▼		Used to reduce the setpoint temperature.
Room temperature	–	20.0 °C	Displays the actual room temperature.
Frost protection	–		Indicates that the frost protection function is active, i.e. that the ventilation unit is protected from frost damage at low temperatures.
Filters	–		Indicates that a filter change is due; the number of operating hours after which a filter should be changed can be configured (the factory setting is 2500 h).  Use the FSL-CONNECT software to reset the counter after a filter change.
Windows	–		Indicates that a window is open. The corresponding window contact signal has been received. The ventilation unit is automatically switched off as a consequence.

## **5 Configuring interfaces to the central BMS**

### **5.1 List of data points**

He, 21.03.2017



## Datenpunktliste X-AIRCONTROL (gültig ab V 1.14)

	Beschreibung Datenpunkte Eingabewerte	LON		BACnet			Modbus (Registeranzahl = 1) Registeradresse
		Variable	Datentyp	Instance	Objekt-Typ	Bemerkung	
1	<u>Vorgabe der Betriebszustände</u>	nviApplicMode	SNVT_hvac_mode	2	Multistate value	2 Zustände	0
2	<u>Betriebsartenvorgabe durch GLI</u>	nviMode	SNVT_occupancy	4	Multistate value	5 Zustände	1
3	<u>Betriebsartenvorgabe durch _Bewegungssensor</u>	nviOccSensor	SNVT_occupancy	6	Multistate value	5 Zustände	2
4	<u>Vorgabe Außentemperatur durch GLI</u>	nviOutsideTemp	SNVT_temp_p	1	Analog value	Temperatur	3
6	<u>Vorgabe Raumtemperatursollwert (relativ)</u>	nviTempOffset	SNVT_temp_p	5	Analog value	Temperatur	5
7	<u>Vorgabe der Raumtemperatur</u>	nviRoomTemp	SNVT_temp_p	6	Analog value	Temperatur	6
8	<u>Vorgabe der relativen Luftfeuchte</u>	nviRelHumid	SNVT_lev_percent	8	Analog value	Prozent	7
10	<u>Vorgabe VOC-Wert im Raum</u>	nviVOC_Room	SNVT_ppm	10	Analog value	VOC-Wert	9
11	<u>Vorgabe VOC-Wert der Außenluft</u>	nviVOC_Outside	SNVT_ppm	12	Analog value	VOC-Wert	10
12	<u>Brandschutzzwangsabschaltung</u>	nviFire	SNVT_hvac_emerg	2	Binary value	2 Zustände	11
13	<u>Abschaltung durch Fensterkontakt</u>	nviWindow	SNVT_switch	3	Binary value	2 Zustände	12
14	<u>Betriebszeitenverlängerung</u>	nviExtraTime	SNVT_switch	4	Binary value	2 Zustände	13
15	<u>Umschaltung Heiz-/Kühlmedium</u>	nviChangeOver	SNVT_switch	7	Multistate value	3 Zustände	14
16	<u>Vorgabe Ventilatorstufe</u>	nviFanSpeed	SNVT_switch	8	Multistate value	7 Zustände	15

Q:\CMM\Produktdokumente\_\und\_Produktdateien\Raumlufttechnische\_Geräte\Dezentrale\_Raumlufttechnische\_Geräte\Betriebsanleitungen\FSL-CONTROL II\170321\_Datenpunkte\_XAC.docx 1

### nviApplicMode

SNVT\_hvac\_mode

Funktion: Vorgabe der Betriebszustände

LON Identifier	BACnet	Modbus (Register 0)	Beschreibung
HVAC_NUL	1	255	Ungültig = keine Einflußnahme
HVAC_NIGHT_PURGE	6	4	Freigabe für die Nachtauskühlung

### nviMode

SNVT\_occupancy

Funktion: Betriebsartenvorgabe durch die GLT

Value LON	Identifier	Value BACnet	Value Modbus (Register 1)	Beschreibung
0	OC_OCCUPIED	1	0	Anwesenheit
1	OC_UNOCCUPIED	2	1	Abwesenheit
2	OC_BYPASS	3	2	Boost
3	OC_STANDBY	4	3	Bereitschaft
255	OC_NUL	5	255	ungültig

### nviOccSensor

SNVT\_occupancy

Funktion: Betriebsartenvorgabe durch bauseitigen busfähigen Sensor (Präsenzmelder)

Value LON	Identifier	Value BACnet	Value Modbus (Register 2)	Beschreibung
0	OC_OCCUPIED	1	0	Anwesenheit
1	OC_UNOCCUPIED	2	1	Abwesenheit
2	OC_BYPASS	3	2	Boost
3	OC_STANDBY	4	3	Bereitschaft
255	OC_NUL	5	255	ungültig



He, 21.03.2017

## nviOutsideTemp

SNVT\_temp\_p

Funktion: Vorgabe der Außentemperatur durch die GLT

Value LON	Value BACnet	Value Modbus (Register 3)
Eingabe mit 2 Nachkommastellen, z.B. -12°C → -12,00	Eingabe mit 2 Nachkommastellen, z.B. -12°C → -12,00	Eingabe ohne Nachkommastellen, mit Faktor 100 multipliziert, z.B. -12,00 °C → -1200
Ungültig bei 327,67	Ungültig bei 327,67	Ungültig bei 327,67

## nviTempOffset

SNVT\_temp\_p

Funktion: Vorgabe des Raumtemperatursollwerts (relativ)

Value LON	Value BACnet	Value Modbus (Register 5)
z.B. 3K → 3	z.B. 3K → 3	z.B. 3K → 3
Ungültig bei 327,67	Ungültig bei 327,67	Ungültig bei 327,67

## nviRoomTemp

SNVT\_temp\_p

Funktion: Vorgabe der Raumtemperatur

Value LON	Value BACnet	Value Modbus (Register 6)
Eingabe mit 2 Nachkommastellen, z.B. 25°C → 25,00	Eingabe mit 2 Nachkommastellen, z.B. 25°C → 25,00	Eingabe ohne Nachkommastellen, mit Faktor 100 multipliziert, z.B. 25,00 °C → 2500
Ungültig bei 327,67	Ungültig bei 327,67	Ungültig bei 327,67



**nviRelHumid**

SNVT\_lev\_percent

Funktion: Vorgabe der relativen Raumlufffeuchte

Value LON	Value BACnet	Value Modbus (Register 7)
-163,840....+163,830	0....100%	0....100%
Ungültig bei +163,830	Ungültig bei 65535	Ungültig bei 65535

**nviVOC\_Room**

SNVT\_ppm

Funktion: Vorgabe des VOC-Wertes im Raum

Value LON	Value BACnet	Value Modbus (Register 9)
0....65535	0....65535	0....65535
Ungültig bei 65535	Ungültig bei 65535	Ungültig bei 65535

**nviVOC\_Outside**

SNVT\_ppm

Funktion: Vorgabe des VOC-Wertes der Außenluft

Value LON	Value BACnet	Value Modbus (Register 10)
0....65535	0....65535	0....65535
Ungültig bei 65535	Ungültig bei 65535	Ungültig bei 65535

**nviFire**

SNVT\_hvac\_emerg

Funktion: Brandschutzzwangsabschaltung

Value LON	Identifizier	Value BACnet	Value Modbus (Register 11)	Beschreibung
0	emerg_normal	0	0	Keine Abschaltung
5	emerg_fire	1	1	Abschaltung

## nviWindow

SNVT\_switch

Funktion: Abschaltung durch Fensterkontakt

LON		BACnet	Modbus (Register 12)	Beschreibung
state	value			
0	XXX	0	0	Fensterkontakt inaktiv
1	XXX	1	1	Fensterkontakt aktiv

## nviExtraTime

SNVT\_switch

Funktion: Verlängerung der Betriebsart Anwesenheit / Boost (Zeitfaktor im X-AIRCONTROL-Regler definierbar)

LON		BACnet	Modbus (Register 13)	Beschreibung
state	value			
0	XXX	0	0	Beim Wechsel von 0 nach 1 erfolgt die Betriebszeitenverlängerung
1	XXX	1	1	

## nviChangeOver

SNVT\_switch

Funktion: Information für den X-AIRCONTROL-Regler, welches Medium (Heizen / Kühlen, für 2-Leiter-Ausführung) zur Verfügung steht

LON		BACnet	Modbus (Register 14)	Beschreibung
state	value			
-1	XXX	1	0	Kein Changeover
1	XXX	2	1	Kühlmedium
0	XXX	3	2	Heizmedium

**nviFanSpeed**

SNVT\_switch

Funktion: Vorgabe der Ventilatorstufe

LON		BACnet	Modbus (Register 15)	Beschreibung
state	value			
1	0	1	1	Ventilatorstufe AUS
1	20	2	10241	Ventilatorstufe 1
1	40	3	20481	Ventilatorstufe 2
1	60	4	30721	Ventilatorstufe 3
1	80	5	40961	Ventilatorstufe 4
1	100	6	51201	Ventilatorstufe 5
0	XXX	7	0	Automatikbetrieb

Modbus: z.B.  $20 \cdot 2 = 40 \Rightarrow 28\text{Hex} + \text{State } 01 \Rightarrow 2801 \text{ Hex} \Rightarrow 10241$

He, 21.03.2017



	Beschreibung Datenpunkte Ausgabewerte	LON		BACnet			Modbus (Registeranzahl = 1) Registeradresse
		Variable	Datentyp	Instance	Objekt-Typ	Bemerkung	
17	<a href="#">Ausgabe aktuelle Zulufttemperatur</a>	nvoSupplyAirTemp	SNVT_temp_p	13	Analog value	Temperatur	16
18	<a href="#">Aktuell verwendete Betriebsart</a>	nvoMode	SNVT_occupancy	5	Multistate value	5 Zustände	17
19	<a href="#">Rückmeldung, wenn Überstundenfunktion aktiv</a>	nvoExtraTime	SNVT_switch	5	Binary value	2 Zustände	18
20	<a href="#">Effektiver Raumtemperatursollwert</a>	nvoEffectSetPt	SNVT_temp_p	14	Analog value	Temperatur	19
21	<a href="#">Rückmeldung Fensterkontakt</a>	nvoWindow	SNVT_switch	6	Binary value	2 Zustände	20
22	<a href="#">Rückmeldung über aktuelle Ventilatorstufe</a>	nvoFanSpeed	SNVT_switch	9	Multistate value	12 Zustände	21
23	<a href="#">Rückmeldung über aktuellen Betriebszustand</a>	nvoApplicMode	SNVT_hvac_mode	3	Multistate value	15 Zustände	22
24	<a href="#">Rückmeldung über aktuelle Außentemperatur</a>	nvoOutsideTemp	SNVT_temp_p	2	Analog value	Temperatur	23
25	<a href="#">Rückmeldung über den eingestellten Temperaturoffset</a>	nvoSetPtOffset	SNVT_temp_p	4	Analog value	Temperatur	24
26	<a href="#">Rückmeldung aktuelle Raumtemperatur</a>	nvoRoomTemp	SNVT_temp_p	7	Analog value	Temperatur	25
27	<a href="#">Rückmeldung rel. Feuchte</a>	nvoRelHumid	SNVT_lev_percent	9	Analog value	Prozent	26
28	<a href="#">Rückmeldung aktueller VOC-Wert</a>	nvoVOCRoom	SNVT_ppm	11	Analog value	VOC-Wert	27
29	<a href="#">Alarmmeldung Frostschutz</a>	nvoFrostAlarm	SNVT_switch	7	Binary value	2 Zustände	28
30	<a href="#">Ausgabe Alarm-/Fehlermeldungen</a>	nvoAlarm1	SNVT_switch	8	Binary value	2 Zustände	29
33	<a href="#">Hardwaremeldungen</a>	nvoHWStatus	SNVT_state	11-17	Binary value	Je 2 Zustände	32
34	<a href="#">Rücklufttemperatur</a>	nvoReturnTemp	SNVT_temp_p	15	Analog value	Temperatur	33
35	<a href="#">Ausgabe Summenvolumenstrom Zuluft</a>	nvoSumSup	SNVT_vol	16	Analog value	Volumenstrom	34
36	<a href="#">Ausgabe Summenvolumenstrom Abluft</a>	nvoSumExh	SNVT_vol	17	Analog value	Volumenstrom	35

Q:\CMM\Produktdokumente\_und\_Produktedaten\Raumlufttechnische\_Geräte\Dezentrale\_Raumlufttechnische\_Geräte\Betriebsanleitungen\FSL-CONTROL II\170321\_Datenpunkte\_XAC.docx 7

					value	
37	<a href="#">Anzahl der KL-Teilnehmer</a>	nvoSystemDevices	SNVT_switch	18	Analog value	1...16
38	<a href="#">Rückmeldung Zwangsabschaltung</a>	nvoFire	SNVT_switch	18	Binary value	3 Zustände
						36
						37

## nvoSupplyAirTemp

SNVT\_temp\_p

Funktion: Ausgabe der aktuellen Zulufttemperatur an die GLT

Value LON	Value BACnet	Value Modbus (Register 16)
Eingabe mit 2 Nachkommastellen, z.B. 23°C → 23,00	Eingabe mit 2 Nachkommastellen, z.B. 23°C → 23,00	Eingabe ohne Nachkommastellen, mit Faktor 100 multipliziert, z.B. 23,00 °C → 2300
Ungültig bei 327,67	Ungültig bei 327,67	Ungültig bei 327,67

## nvoMode / ActMode

SNVT\_occupancy

Funktion: Ausgabe der aktuell verwendeten Betriebsart an die GLT

Value LON	Identifizier	Value BACnet	Value Modbus (Register 17)	Beschreibung
0	OC_OCCUPIED	1	0	Anwesenheit
1	OC_UNOCCUPIED	2	1	Abwesenheit
2	OC_BYPASS	3	2	Boost
3	OC_STANDBY	4	3	Bereitschaft
255	OC_NUL	5	255	ungültig

## nvoExtraTime / ActExtraTime

SNVT\_switch

Funktion: Rückmeldung an die GLT, wenn die Überstundenfunktion aktiv ist

LON		BACnet	Modbus (Register 18)	Beschreibung
state	value			
0	XXX	0	0	Bei 1 ist die Betriebszeitenverlängerung aktiv
1	XXX	1	1	



He, 21.03.2017

**nvoEffectSetPt**

SNVT\_temp\_p

Funktion: Rückmeldung über den effektiven Raumtemperatursollwert an die GLT

Value LON	Value BACnet	Value Modbus (Register 19)
Eingabe mit 2 Nachkommastellen, z.B. 26°C →26,00	Eingabe mit 2 Nachkommastellen, z.B. 26°C →26,00	Eingabe ohne Nachkommastellen, mit Faktor 100 multipliziert, z.B. 26,00 °C → 2600
Ungültig bei 327,67	Ungültig bei 327,67	Ungültig bei 327,67

**nvoWindow / ActWindow**

SNVT\_switch

Funktion: Rückmeldung ob der Fensterkontakt aktiv ist

LON		BACnet	Modbus (Register 20)	Beschreibung
state	value			
0	XXX	0	0	Fensterkontakt nicht aktiv
1	XXX	1	1	Fensterkontakt aktiv

Q:\CM\Produktdokumente\_und\_Produktdaten\Raumluftechnische\_Geräte\Dezentrale\_raumluftechnische\_Geräte\Betriebsanleitungen\FSL-CONTROL IIV170321\_Datenpunkte XAC.docx 10



He, 21.03.2017

## nvoFanSpeed / ActFanSpeed

SNVT\_switch

Funktion: Rückmeldung über die aktuelle Ventilatorstufe an die GLT

LON		BACnet	Modbus (Register 21)	Beschreibung
state	value			
1	0	1	1	Ventilatorstufe AUS, manuell
1	20	2	10241	Ventilatorstufe 1, manuell
1	40	3	20481	Ventilatorstufe 2, manuell
1	60	4	30721	Ventilatorstufe 3, manuell
1	80	5	40961	Ventilatorstufe 4, manuell
1	100	6	51201	Ventilatorstufe 5, manuell
0	0	7	0	Ventilator AUS, Automatikbetrieb
0	20	8	10240	Ventilatorstufe 1, Automatikbetrieb
0	40	9	20480	Ventilatorstufe 2, Automatikbetrieb
0	60	10	30720	Ventilatorstufe 3, Automatikbetrieb
0	80	11	40960	Ventilatorstufe 4, Automatikbetrieb
0	100	12	51200	Ventilatorstufe 5, Automatikbetrieb





He, 21.03.2017

**nvoApplicMode / ActApplicMode**

SNVT\_hvac\_mode

Funktion: Rückmeldung an die GLT über den aktuellen Betriebszustand

Value LON	Identifier	Value BACnet	Value Modbus (Register 22)	Beschreibung
-1 (0xFF)	HVAC_NUL	1	255	Keine Funktion
0	HVAC_AUTO	2	0	Automatikmodus
1	HVAC_HEAT	3	1	Heizmodus
3	HVAC_COOL	5	3	Kühlmodus
4	HVAC_NIGHT_PURGE	6	4	Nachtauskühlung
6	HVAC_OFF	8	6	Keine Lüftung
8	HVAC_EMERG_HEAT	10	8	Frostschutz
9	HVAC_FAN_ONLY	11	9	Nur Lüftungsbetrieb
10	HVAC_FREE_COOL	12	10	Freies Kühlen
12	HVAC_MAX_HEAT	13	12	Anfahrhaltung
1	HVAC_ECONOMY	3	1	Freies Heizen

**nvoOutsideTemp / ActOutsideTemp**

SNVT\_temp\_p

Funktion: Rückmeldung der aktuellen Außentemperatur an die GLT

Value LON	Value BACnet	Value Modbus (Register 23)
Eingabe mit 2 Nachkommastellen, z.B. -12°C → -12,00	Eingabe mit 2 Nachkommastellen, z.B. -12°C → -12,00	Eingabe ohne Nachkommastellen, mit Faktor 100 multipliziert, z.B. -12,00 °C → -1200
Ungültig bei 327,67	Ungültig bei 327,67	Ungültig bei 327,67

Q:\CM\Produktdokumente\_und\_Produktdaten\Raumlufttechnische\_Geräte\Dezentrale\_raumlufttechnische\_Geräte\Betriebsanleitungen\FSL-CONTROL III\70321\_Datenpunkte XAC.docx 12



He, 21.03.2017

## nvoSetPtOffset

SNVT\_temp\_p

Funktion: Rückmeldung über den eingestellten Temperaturoffset an die GLT

Value LON	Value BACnet	Value Modbus (Register 24)
Eingabe z.B. 3K →3	Eingabe z.B. 3K →3	Eingabe z.B. 3K → 3
Ungültig bei 327,67	Ungültig bei 327,67	Ungültig bei 327,67

## nvoRoomTemp / ActRoomTemp

SNVT\_temp\_p

Funktion: Rückmeldung über die aktuelle Raumtemperatur an die GLT

Value LON	Value BACnet	Value Modbus (Register 25)
Eingabe mit 2 Nachkommastellen, z.B. 23°C →23,00	Eingabe mit 2 Nachkommastellen, z.B. 23°C →23,00	Eingabe ohne Nachkommastellen, mit Faktor 100 multipliziert, z.B. 23,00 °C → 2300
Ungültig bei 327,67	Ungültig bei 327,67	Ungültig bei 327,67

## nvoRelHumid / ActRelHumid

SNVT\_lev\_percent

Funktion: Rückmeldung über die aktuelle relative Raumfeuchte an die GLT (zusätzliche Hardware erforderlich oder Vorgabe durch die GLT)

Value LON	Value BACnet	Value Modbus (Register 26)
-163,840....+163,830	0....100%	0....100%
Ungültig bei +163,830	Ungültig bei 65535	Ungültig bei 65535



He, 21.03.2017

### nvoVOC\_Room / ActVOC\_Room

SNVT\_ppm

Funktion: Rückmeldung über den aktuellen VOC-Wert im Raum an die GLT  
(zusätzliche Hardware erforderlich oder Vorgabe durch die GLT)

Value LON	Value BACnet	Value Modbus (Register 27)
0...65535	0...65535	0...65535
Ungültig bei 65535	Ungültig bei 65535	Ungültig bei 65535

### nvoFrostAlarm

SNVT\_switch

Funktion: Alarmmeldung Frostschutz

LON		BACnet	Modbus (Register 28)	Beschreibung
state	value			
0	XXX	0	0	Frostschutzalarm inaktiv
1	XXX	1	1	Frostschutzalarm aktiv

### nvoAlarm1

SNVT\_switch

Funktion: Sammelalarmmeldung Kategorie 1 (Spannungsüberwachung und  
Temperaturfühlerausfall)

LON		BACnet	Modbus (Register 29)	Beschreibung
state	value			
0	XXX	0	0	Alarm inaktiv
1	XXX	1	1	Alarm aktiv



He, 21.03.2017

## nvoHWStatus

SNVT\_state

Funktion: Hardwaremeldungen über 16-Bitleiste.

Folgende Auflistung ist gültig für LON und Modbus (Register 32):

- Bit 0: XXX
- Bit 1: XXX
- Bit 2: fan blocked
- Bit 3: XXX
- Bit 4: Filteralarm
- Bit 5: XXX
- Bit 6: XXX
- Bit 7 bis Bit 15 XXX

Folgende Auflistung ist gültig für BACnet:

- Instance 11: Power supply
- Instance 12: Mastermodul SEM-AWIO
- Instance 13: fan blocked
- Instance 14: Sensor Error
- Instance 15: Filteralarm
- Instance 16 und 17 werden nicht verwendet

## nvoReturnTemp

SNVT\_temp\_p

Funktion: Rückmeldung über die aktuelle Rücklauftemperatur an die GLT (zusätzliche Hardware erforderlich)

Value LON	Value BACnet	Value Modbus (Register 33)
Eingabe mit 2 Nachkommastellen, z.B. 23°C → 23,00	Eingabe mit 2 Nachkommastellen, z.B. 23°C → 23,00	Eingabe ohne Nachkommastellen, mit Faktor 100 multipliziert, z.B. 23,00 °C → 2300
Ungültig bei 327,67	Ungültig bei 327,67	Ungültig bei 327,67

## nvoSumSup

SNVT\_vol

Funktion: Rückmeldung des Summenvolumenstroms Zuluft aller in diesem Regelkreis angesteuerten Geräte (Master und Slave). Die Ausgabe erfolgt als Zahlenwert in [l/s] und ist für LON, BACnet und Modbus identisch.

## 5.2 BACnet MS/TP interface

### BACnet Protocol Implementation Conformance Statement

**Date:** 23.09.2013  
**Vendor Name:** TROX GmbH  
**Product Name:** EM-BAC-MOD-01 XAC  
**Product Model Number:** A00000020207  
**Application Software Version:** 1.0  
**Firmware Revision:** 1.0  
**BACnet Protocol Revision:** 12

#### Product Description:

Expansion module for X-AIRCONTROL controllers providing a BACnet MS/TP Interface.

#### BACnet Standardized Device Profile (Annex L):

- BACnet Operator Workstation (B-OWS)
- BACnet Advanced Operator Workstation (B-AWS)
- BACnet Operator Display (B-OD)
- BACnet Building Controller (B-BC)
- BACnet Advanced Application Controller (B-AAC)
- BACnet Application Specific Controller (B-ASC)
- BACnet Smart Sensor (B-SS)
- BACnet Smart Actuator (B-SA)

#### List all BACnet Interoperability Building Blocks Supported (Annex K):

Data Sharing-ReadProperty-B (DS-RP-B)  
 Data Sharing-WriteProperty-B (DS-WP-B)  
 Data Sharing-COV-Unsolicited-B (DS-COVU-B)  
 Device Management-Dynamic Device Binding-B (DM-DDB-B)  
 Device Management-Dynamic Object Binding-B (DM-DOB-B)  
 Device Management-DeviceCommunicationControl-B (DM-DCC-B)  
 Device Management-ReinitializeDevice-B (DM-RD-B)

#### Segmentation Capability:

- Able to transmit segmented messages Window Size \_\_\_\_\_
- Able to receive segmented messages Window Size \_\_\_\_\_

#### Standard Object Types Supported:

An object type is supported if it may be present in the device. For each standard Object Type supported provide the following data:

- 1) Whether objects of this type are dynamically creatable using the CreateObject service
- 2) Whether objects of this type are dynamically deletable using the DeleteObject service
- 3) List of the optional properties supported
- 4) List of all properties that are writable where not otherwise required by this standard
- 5) List of all properties that are conditionally writable where not otherwise required by this standard
- 6) List of proprietary properties and for each its property identifier, datatype, and meaning
- 7) List of any property range restrictions

**Data Link Layer Options:**

- BACnet IP, (Annex J)
- BACnet IP, (Annex J), Foreign Device
- ISO 8802-3, Ethernet (Clause 7)
- ATA 878.1, 2.5 Mb. ARCNET (Clause 8)
- ATA 878.1, EIA-485 ARCNET (Clause 8), baud rate(s) \_\_\_\_\_
- MS/TP master (Clause 9), baud rate(s): 9600, 19200, 38400, 76800
- MS/TP slave (Clause 9), baud rate(s): \_\_\_\_\_
- Point-To-Point, EIA 232 (Clause 10), baud rate(s): \_\_\_\_\_
- Point-To-Point, modem, (Clause 10), baud rate(s): \_\_\_\_\_
- LonTalk, (Clause 11), medium: \_\_\_\_\_
- BACnet/ZigBee (ANNEX O)
- Other: \_\_\_\_\_

**Device Address Binding:**

Is static device binding supported? (This is currently necessary for two-way communication with MS/TP slaves and certain other devices.)  Yes  No

**Networking Options:**

- Router, Clause 6 - List all routing configurations, e.g., ARCNET-Ethernet, Ethernet-MS/TP, etc.
- Annex H, BACnet Tunneling Router over IP
- BACnet/IP Broadcast Management Device (BBMD)
  - Does the BBMD support registrations by Foreign Devices?  Yes  No
  - Does the BBMD support network address translation?  Yes  No

**Network Security Options:**

- Non-secure Device - is capable of operating without BACnet Network Security
- Secure Device - is capable of using BACnet Network Security (NS-SD BIBB)
  - Multiple Application-Specific Keys:
  - Supports encryption (NS-ED BIBB)
  - Key Server (NS-KS BIBB)

**Character Sets Supported:**

Indicating support for multiple character sets does not imply that they can all be supported simultaneously.

- ISO 10646 (UTF-8)                       IBM™/Microsoft™ DBCS                       ISO 8859-1
- ISO 10646 (UCS-2)                       ISO 10646 (UCS-4)                       JIS X 0208

**If this product is a communication gateway, describe the types of non-BACnet equipment/networks(s) that the gateway supports:**

---



---



---

## Configuration Switches

Hexadecimal Switches X, Y	Network-Address
---------------------------	-----------------

DIP Switch 2	OFF	ON	OFF	ON
DIP Switch 3	OFF	OFF	ON	ON
Baudrate	9600	19200	38400	76800

## Device Object

Property	Remark / Value	RW
Object_Identifier	device, default instance: 32900 + Address Switch	RW-E
Object_Name	max. 50 Bytes, default "EM-BACnet"	RW-E
Object_Type	DEVICE (8)	R
System_Status	OPERATIONAL (0)	R
Vendor_Name	"TROX GmbH"	R
Vendor_Identifier	329	R
Model_Name	"EM-BAC-MOD-01 XAC"	R
Firmware_Revision	"1.0"	R
Application_Software_Version	"1.0"	R
Protocol_Version	1	R
Protocol_Revision	12	R
Protocol_Services_Supported	read-property, write-property, device-communication-control, reinitialize-device, who-has, who-is	R
Protocol_Object_Types_Supported	DEVICE, ANALOG_VALUE, BINARY_VALUE, MULTISTATE_VALUE	R
Object_List	device, analog-value 1...18, binary-value 1...20, multistate-value 1...9	R
Max_APDU_Length_Accepted	480	R
Segmentation_Supported	NO_SEGMENTATION (3)	R
APDU_Timeout	3000	R
Number_Of_APDU_Retries	0	R
Device_Address_Binding	-	R
Database_Revision	0	R
Description	Controller Type "X-AIRCONTROL"	R
Max_Master	default 127	RW-E
Max_Info_Frames	default 1	RW-E
R: Read Property, W: Write Property, -E: Storage in EEPROM		

## Analog Value Objects

Property	Remark / Value	RW
Object_Identifier	analog-value, instance 1 ... 18	R
Object_Name		R
Object_Type	ANALOG_VALUE (2)	R
Present_Value		
Status_Flags	IN_ALARM: 0 FAULT: 0 OVERRIDDEN: 0 OUT_OF_SERVICE: 0	R
Event_State	NORMAL (0)	R
Out_Of_Service	FALSE (0)	R
Units		R
R: Read Property, W: Write Property		

Instance	Object_Name	Units	Initial Present_Value	Present_Value
1	"OutsideTemp"	degrees-Celsius (62)	327.67	RW
2	"ActOutsideTemp"	degrees-Celsius (62)	327.67	R
3	"RoomTemp_Set"	degrees-Celsius (62)	327.67	RW
4	"SetptOffset"	degrees-Celsius (62)	327.67	R
5	"TempOffset"	degrees-Celsius (62)	327.67	RW
6	"RoomTemp"	degrees-Celsius (62)	327.67	RW
7	"ActRoomTemp"	degrees-Celsius (62)	327.67	R
8	"RelHumid"	percent-relative-humidity (29)	0	RW
9	"ActRelHumid"	percent-relative-humidity (29)	0	R
10	"VOC_Room"	parts-per-million (96)	0	RW
11	"ActVOC_Room"	parts-per-million (96)	0	R
12	"VOC_Outside"	parts-per-million (96)	0	RW
13	"DischAirTemp"	degrees-Celsius (62)	327.67	R
14	"EffectSetpt"	degrees-Celsius (62)	327.67	R
15	"RTemp"	degrees-Celsius (62)	327.67	R
16	"Sum_Sup"	liters-per-second (87)	0	R
17	"Sum_Exh"	liters-per-second (87)	0	R
18	"SystemDevices"	no-units (95)	0	R



## Binary Value Objects

Property	Remark / Value	RW
Object_Identifier	binary-value, instance 1 ... 20	R
Object_Name		R
Object_Type	BINARY_VALUE (5)	R
Present_Value	INACTIVE (0, Initial) / ACTIVE (1)	
Status_Flags	IN_ALARM: 0 FAULT: 0 OVERRIDDEN: 0 OUT_OF_SERVICE: 0	R
Event_State	NORMAL (0)	R
Out_Of_Service	FALSE (0)	R
Inactive_Text		R
Active_Text		R
R: Read Property, W: Write Property, COVU: Unsolicited Change of Value Notification		

Instance	Object_Name	Inactive_Text	Active_Text	Present_Value
1	"StartPCM"	"Off"	"On"	RW
2	"Fire"	"Normal"	"Fire"	RW
3	"Window"	"Close"	"Open"	RW
4	"ExtraTime"	"Inactive"	"Active"	RW
5	"ActExtraTime"	"Inactive"	"Active"	R
6	"ActWindow"	"Close"	"Open"	R
7	"FAAlarm"	"Normal"	"Frostalarm"	R COVU
8	"Alarm1"	"Normal"	"Alarm1"	R COVU
9	"Alarm2"	"Normal"	"Alarm2"	R COVU
10	"Release"	"Off"	"On"	R
11	"Status_PowerSupply"	"Normal"	"LowPower"	R COVU
12	"Status_EMFSLIO"	"Normal"	"ComFail"	R COVU
13	"Status_Fan"	"Normal"	"FanBlocked"	R COVU
14	"Status_Sensor"	"Normal"	"SensorFail"	R COVU
15	"Status_Filter"	"Normal"	"FilterAlarm"	R COVU
16	"Status_FlowControl"	"Normal"	"FlowAlarm"	R COVU
17	"Status_Damper"	"Normal"	"CalibrationFail"	R COVU
18	"ActFire"	"Normal"	"Fire"	R
19	"FanForce"	"Inactive"	"Active"	RW
20	"ActFanForce"	"Inactive"	"Active"	R

## Multistate Value Objects

Property	Remark / Value	RW
Object_Identifier	multistate-value, instance 1 ... 9	R
Object_Name		R
Object_Type	MULTISTATE_VALUE (19)	R
Present_Value	State	
Status_Flags	IN_ALARM: 0 FAULT: 0 OVERRIDDEN: 0 OUT_OF_SERVICE: 0	R
Event_State	NORMAL (0)	R
Out_Of_Service	FALSE (0)	R
Number_Of_States		R
State_Text		R
R: Read Property, W: Write Property, -E: Storage in EEPROM		

Instance	Number_Of_States	Object_Name	State	State_Text	Present_Value
1	3	“COV-Mode”	1 2 3 (initial)	“Disabled” “Local Broadcast” “Global Broadcast”	RW-E
2	15	“ApplicMode”	1 (initial) 2 3 4 5 6 7 8 9 10 11 12 13 14 15	“HVAC_NUL” “HVAC_AUTO” “HVAC_HEAT” “HVAC_MRNG_WRMUP” “HVAC_COOL” “HVAC_NIGHT_PURGE” “HVAC_PRE_COOL” “HVAC_OFF” “HVAC_TEST” “HVAC_EMERG_HEAT” “HVAC_FAN_ONLY” “HVAC_FREE_COOL” “HVAC_MAXHEAT” “HVAC_ECONOMY” “HVAC_DEHUMID”	RW
3	15	“ActApplicMode”	1 (initial) 2 3 4 5 6 7 8 9 10 11 12 13 14 15	“HVAC_NUL” “HVAC_AUTO” “HVAC_HEAT” “HVAC_MRNG_WRMUP” “HVAC_COOL” “HVAC_NIGHT_PURGE” “HVAC_PRE_COOL” “HVAC_OFF” “HVAC_TEST” “HVAC_EMERG_HEAT” “HVAC_FAN_ONLY” “HVAC_FREE_COOL” “HVAC_MAXHEAT” “HVAC_ECONOMY” “HVAC_DEHUMID”	R

Instance	Number_ Of_States	Object_Name	State	State_Text	Present_Value
4	5	“Mode”	1 2 3 4 5 (initial)	“OCCUPIED” “UNOCCUPIED” “BOOST” “STANDBY” “NUL”	RW
5	5	“ActMode”	1 2 3 4 5 (initial)	“OCCUPIED” “UNOCCUPIED” “BOOST” “STANDBY” “NUL”	R
6	4	“OccSensor”	1 2 3 4 5 (initial)	“OCCUPIED” “UNOCCUPIED” “BOOST” “STANDBY” “NUL”	RW
7	3	“ChangeOver”	1 (initial) 2 3	“Off” “COOLING” “HEATING”	RW
8	7	“FanSpeed”	1 2 3 4 5 6 7 (initial)	“Off” “LEVEL1” “LEVEL2” “LEVEL3” “LEVEL4” “LEVEL5” “AUTO”	RW
9	12	“ActFanSpeed”	1 2 3 4 5 6 7 (initial) 8 9 10 11 12	“Off”           Hand “LEVEL1” “LEVEL2” “LEVEL3” “LEVEL4” “LEVEL5” “Off”           Auto “LEVEL1” “LEVEL2” “LEVEL3” “LEVEL4” “LEVEL5”	R



## 5.3 Modbus RTU interface

### Expansion module EM-BAC-MOD-01 XAC

#### When used in the X-AIRCONTROL base device

#### Communication via Modbus RTU

##### **Switches and status LEDs**

Green LED, illuminated: Power is being supplied to the device.  
Green LED, blinking: Data is being received via Modbus.

Red LED, flashes: Modbus transmission error.

Slide switch: Used to switch between Modbus and BACnet.

Rotary switches: Used to set device addresses (Modbus slave address).  
Valid addresses are 01-99; devices with one of these addresses can communicate via Modbus. Address 00 is reserved for broadcast; a device with this address can receive, but not send data.

The dip switch is used to set the operating mode:

Switch 2	OFF	ON	OFF	ON
Switch 3	OFF	OFF	ON	ON
Baud rate	9600	19200	38400	57600
Switch 5	OFF	ON	OFF	ON
Switch 6	OFF	OFF	ON	ON
Parity	none	none	odd	even

Switches 1,4,7 and 8 have no function.

If you change a switch setting, the device will be reset after about 1 s and restarted with the new setting.

##### **Frame timing with Modbus RTU**

Modbus frames are separated by gaps, or intervals. The following intervals apply to rates of up to 19200 Bd; values for higher Baud rates are given in brackets:

- Send process: A maximum of 1.5 character times (750µs) is considered an interval between 2 characters of a frame.
- Send process: An interval between 2 frames must be at least 3.5 character times (1750µs).
- The range between these values is considered a tolerance range by the recipient.  
If this interval is exceeded during a send process, the frame ends.

This module sends messages (characters) continuously, i.e. without intervals. There is a silent interval of  $\geq 3.6$  character times (1800µs) before the send process starts.  
A receive process ends after an interval of about 2.5 character times (1250µs).

## **Modbus functions**

The device includes the following functions:

Function 1 (0x01) Read Coils  
Function 3 (0x03) Read Holding Registers  
Function 4 (0x04) Read Input Registers  
Function 5 (0x05) Write Single Coil  
Function 6 (0x06) Write Single Register  
Function 8 (0x08) Diagnostics  
Function 16 (0x10) Write Multiple Registers  
Function 43/14 (0x02B/0x0E) Read Device Identification

The encoding for the corresponding Modbus RTU frames is shown below (shown without CRC). For data with 2 bytes the High-Byte comes first.

Meaning of exception codes:

- |   |                       |  |
|---|-----------------------|--|
| 1 | Illegal function code | Unknown code for this function or subfunction.                                 |
| 2 | Illegal Data Address  | Invalid register address.  |
| 3 | Illegal Data Value    | Inconsistent encoding in the number of registers, number of bytes, data value. |

### **Modbus function 3 (0x03) Read Holding Registers**

### **Modbus function 4 (0x04) Read Input Registers**

These functions are used to read several consecutive registers. Both functions are identical.

Request:

Byte 0	Slave Address	Rotary switch 1-99
Byte 1	Function Code	0x03 / 0x04
Byte 2-3	Register Address	First register
Byte 4-5	Register Quantity	No. of registers

Response:

Byte 0	Slave Address	Rotary switch 1-99
Byte 1	Function Code	0x03 / 0x04
Byte 2	Byte Count	2 bytes per register
Byte 3-4	Register Value	0x0000-0xFFFF
Byte ...	Register Value	0x0000-0xFFFF

Error:

Byte 0	Slave Address	Rotary switch 1-99
Byte 1	Error Code	0x83 / 0x84
Byte 2	Exception Code	0x02, 0x03

## Modbus function 06 (0x06) Write Single Register

This function is used to write to a single register.

### Request:

Byte 0	Slave Address	Rotary switch 1-99
Byte 1	Function Code	0x06
Byte 2-3	Register Address	Address of the register
Byte 4-5	Register Value	0x0000-0xFFFF

### Response:

Byte 0	Slave Address	Rotary switch 1-99
Byte 1	Function Code	0x06
Byte 2-3	Register Address	Address of the register
Byte 4-5	Register Value	0x0000-0xFFFF

### Error:

Byte 0	Slave Address	Rotary switch 1-99
Byte 1	Error Code	0x86
Byte 2	Exception Code	0x02,0x03

## Modbus function 16 (0x10) Write Multiple Registers

This function is used to write to several consecutive registers.

### Request:

Byte 0	Slave Address	Rotary switch 1-99
Byte 1	Function Code	0x10
Byte 2-3	Register Address	First register
Byte 4-5	Register Quantity	No. of registers
Byte 6	Byte Count	2 bytes per register
Byte 7-8	Register Value	0x0000-0xFFFF
Byte ...	Register Value	0x0000-0xFFFF

### Response:

Byte 0	Slave Address	Rotary switch 1-99
Byte 1	Function Code	0x10
Byte 2-3	Register Address	First register
Byte 4-5	Register Quantity	No. of registers

### Error:

Byte 0	Slave Address	Rotary switch 1-99
Byte 1	Error Code	0x90
Byte 2	Exception Code	0x02,0x03

## Modbus function 1 (0x01) Read Coils

This function is used to read the state of several bits.

### Request:

Byte 0	Slave Address	Rotary switch 1-99
Byte 1	Function Code	0x01
Byte 2-3	Starting Address	Number of the first bit
Byte 4-5	Quantity of Coils	Number of bits

### Response:

Byte 0	Slave Address	Rotary switch 1-99
Byte 1	Function Code	0x01
Byte 2	Byte Count	Number of bytes
Byte 3	Coil Status	Bit values
Byte ...	Coil Status	Bit values

### Error:

Byte 0	Slave Address	Rotary switch 1-99
Byte 1	Error Code	0x81
Byte 2	Exception Code	0x02,0x03

## Modbus function 5 (0x05) Write Single Coil

This function is used to write to a single bit.

### Request:

Byte 0	Slave Address	Rotary switch 1-99
Byte 1	Function Code	0x05
Byte 2-3	Output Address	Bit number
Byte 4-5	Output Value	0x0000 (false), 0xFF00 (true)

### Response:

Byte 0	Slave Address	Rotary switch 1-99
Byte 1	Function Code	0x05
Byte 2-3	Output Address	Bit number
Byte 4-5	Output Value	0x0000 (false), 0xFF00 (true)

### Error:

Byte 0	Slave Address	Rotary switch 1-99
Byte 1	Error Code	0x85
Byte 2	Exception Code	0x02,0x03



## Modbus function 8 (0x08) Diagnostics

This function is used to check the Modbus communication.

### Request:

Byte 0	Slave Address	Rotary switch 1-99
Byte 1	Function Code	0x08
Byte 2-3	Subfunction	see below
Byte 4-5	Data	see below

### Response:

Byte 0	Slave Address	Rotary switch 1-99
Byte 1	Function Code	0x08
Byte 2-3	Subfunction	see below
Byte 4-5	Data	see below

### Error:

Byte 0	Slave Address	Rotary switch 1-99
Byte 1	Error Code	0x88
Byte 2	Exception Code	0x01,0x03

Sub- func.	Data Requ.	Data Resp.	Name Meaning
0	*	*	Return Query Data The whole frame (100 bytes max.) is sent back.
1	x	x	Restart Communications Option Modbus communication restarts after the response, Listen Only Mode ends.
4	0	-	Force Listen Only Mode No response is sent. Listen Only Mode starts immediately. The device reacts only to the Diagnostics function, Restart Communications Option subfunction.
10	0	0	Clear Counters All 5 diagnosis counters are deleted.
11	0	Count	Return Bus Message Count Request the number of error-free messages received.
12	0	Count	Return Bus Communication Error Count Number of messages with a CRC error, length < 3, request parity error or framing error
13	0	Count	Return Slave Exception Error Count Request number of error messages.
14	0	Count	Return Slave Message Count Request number of messages for this device.
15	0	Count	Return Slave No Response Count Request number of broadcast messages.

## Modbus function 43/14 (0x02B/0x0E) Read Device Identification

This function is used to read data required for identifying the device.

### Request:

Byte 0	Slave Address	Rotary switch 1-99
Byte 1	Function Code	0x2B
Byte 2	MEI-Type	0x0E
Byte 3	Read Device ID Code	0x01
Byte 4	Object ID	0x00

### Response:

Byte 0	Slave Address	Rotary switch 1-99
Byte 1	Function Code	0x2B
Byte 2	MEI-Type	0x0E
Byte 3	Read Device ID Code	0x01
Byte 4	Conformity Level	0x01
Byte 5	More Follows	0x00
Byte 6	Next Object ID	0x00
Byte 7	Number of Objects	0x03
Byte 8	ID: VendorName	0x00
Byte 9	Obj-Length	9
Byte 10-18	Obj-Value	"TROX GmbH"
Byte 19	ID: ProductCode	0x01
Byte 20	Obj-Length	17
Byte 21-37	Obj-Value	"EM-BAC-MOD-01 XAC"
Byte 38	ID: MajMinRevision	0x02
Byte 39	Obj-Length	4
Byte 40-43	Obj-Value	"V1.0"

### Error:

Byte 0	Slave Address	1-99
Byte 1	Error Code	0xAB
Byte 2	Exception Code	0x01-0x03

## Modbus register

The SPI interface protocol defines commands for sending and for receiving useful data. Each of these SPI commands is assigned a Modbus register. The SPI interface reads certain registers and writes to others, depending on the command. It is, however, possible to read all Modbus registers and to write to all Modbus registers.

The sequence of the registers is the same as the sequence of the commands of the SPI interface. Each Modbus register is 2 bytes.

The contents of the registers is the same as the useful data of the SPI interface. In the only re-encoding step, the high byte and the low byte of the SPI interface are distributed to different Modbus registers as required; see the SPI byte column.

## List of registers for X-AIRCONTROL

Direction column: EM = expansion module, GG = base device

Modbus values column:

uint16 = integer without prefix  
 sint16 = integer with prefix  
 0 - 100 = value with unit of measure %  
 0 - 1 = binary values  
 0 - 2... = Selection of operating modes

SPI bytes column

High, Low Both bytes are identical for Modbus and SPI  
 Low, (High=0) Only the Low byte is valid, the High byte is deleted

Register address	Useful data name	Direction EM / GG	Modbus values	Modbus default	SPI bytes	Encoding / Unit / Resolution
0	ApplicMode	EM -> GG	255, 0 - 10, 12 - 14	255	Low, (High=0)	255 = HVAC_NUL 0 = HVAC_AUTO 1 = HVAC_HEAT 2 = HVAC_MRNG_WRMUP 3 = HVAC_COOL 4 = HVAC_NIGHT_PURGE 5 = HVAC_PRE_COOL 6 = HVAC_OFF 7 = HVAC_TEST 8 = HVAC_EMERG_HEAT 9 = HVAC_FAN_ONLY 10 = HVAC_FREE_COOL 12 = HVAC_MAXHEAT 13 = HVAC_ECONOMY 14 = HVAC_DEHUMID
1	Mode	EM -> GG	255, 0, 1, 2, 3	255	Low, (High=0)	255 = Nul 0 = Occupied 1 = Unoccupied 2 = Boost 3 = Standby
2	OCCSensor	EM -> GG	255, 0, 1, 2, 3	255	Low, (High=0)	255 = Nul 0 = Occupied 1 = Unoccupied 2 = Boost 3 = Standby
3	OutsideTemp	EM -> GG	sint16	0x7FFF	High, Low	Unit 0.01°C
4	RoomTemp_Set	EM -> GG	sint16	0x7FFF	High, Low	Unit 0.01°C
5	TempOffset	EM -> GG	sint16	0x7FFF	High, Low	Unit 0.01°C
6	RoomTemp	EM -> GG	sint16	0x7FFF	High, Low	Unit 0.01°C

Register address	Useful data name	Direction EM / GG	Modbus values	Modbus default	SPI bytes	Encoding / Unit / Resolution
7	RelHumid	EM -> GG	0 - 100	0	Low, (High=0)	Unit %
8	StartPCM	EM -> GG	0 - 1	0	Low, (High=0)	
9	VOC_Room	EM -> GG	uint16	0	High, Low	Unit ppm
10	VOC_Outside	EM -> GG	uint16	0	High, Low	Unit ppm
11	Fire	EM -> GG	0 - 1	0	Low, (High=0)	
12	Window	EM -> GG	0 - 1	0	Low, (High=0)	
13	ExtraTime	EM -> GG	0 - 1	0	Low, (High=0)	
14	ChangeOver	EM -> GG	0 - 2	0	Low, (High=0)	0 = off 1 = cooling 2 = heating
15	FanSpeed	EM -> GG	see Encoding	0; 0	High, Low	High-Byte: Value, Low-Byte: 0 Auto, 1 Hand 0x0001 = 0; 1 = Off 0x2801 = 40; 1 = Level 1 0x5001 = 80; 1 = Level 2 0x7801 = 120; 1 = Level 3 0xA001 = 160; 1 = Level 4 0xC801 = 200; 1 = Level 5 0x0000 = 0; 0 = Auto
16	DischAirTemp	GG -> EM	sint16	0x7FFF	High, Low	Unit 0.01°C
17	ActMode	GG -> EM	255, 0, 1, 2, 3	255	Low, (High=0)	255 = Nul 0 = Occupied 1 = Unoccupied 2 = Boost 3 = Standby
18	ActExtraTime	GG -> EM	0 - 1	0	Low, (High=0)	
19	EffectSetpt	GG -> EM	sint16	0x7FFF	High, Low	Unit 0.01°C
20	ActWindow	GG -> EM	0 - 1	0	Low, (High=0)	
21	ActFanSpeed	GG -> EM	see Encoding	0; 0	High, Low	High-Byte: Value, Low-Byte: 0 Auto, 1 Hand 0x0001 = 0; 1 = Off, Hand 0x2801 = 40; 1 = Level 1 0x5001 = 80; 1 = Level 2 0x7801 = 120; 1 = Level 3 0xA001 = 160; 1 = Level 4 0xC801 = 200; 1 = Level 5 0x0000 = 0; 0 = Off, Auto 0x2800 = 40; 0 = Level 1 0x5000 = 80; 0 = Level 2 0x7800 = 120; 0 = Level 3 0xA000 = 160; 0 = Level 4 0xC800 = 200; 0 = Level 5
22	ActApplicMode	GG -> EM	255, 0 - 10, 12 - 14	255	Low, (High=0)	255 = HVAC_NUL 0 = HVAC_AUTO 1 = HVAC_HEAT 2 = HVAC_MRNG_WRMUP 3 = HVAC_COOL 4 = HVAC_NIGHT_PURGE 5 = HVAC_PRE_COOL 6 = HVAC_OFF 7 = HVAC_TEST 8 = HVAC_EMERG_HEAT 9 = HVAC_FAN_ONLY 10 = HVAC_FREE_COOL 12 = HVAC_MAXHEAT 13 = HVAC_ECONOMY 14 = HVAC_DEHUMID
23	ActOutsideTemp	GG -> EM	sint16	0x7FFF	High, Low	Unit 0.01°C
24	SetptOffset	GG -> EM	sint16	0x7FFF	High, Low	Unit 0.01°C
25	ActRoomTemp	GG -> EM	sint16	0x7FFF	High, Low	Unit 0.01°C
26	ActRelHumid	GG -> EM	0 - 100	0	Low, (High=0)	Unit %
27	ActVOC_Room	GG -> EM	uint16	0	High, Low	Unit ppm
28	FAlarm	GG -> EM	0 - 1	0	Low, (High=0)	
29	Alarm1	GG -> EM	0 - 1	0	Low, (High=0)	

Register address	Useful data name	Direction EM / GG	Modbus values	Modbus default	SPI bytes	Encoding / Unit / Resolution
30	Alarm2	GG -> EM	0 - 1	0	Low, (High=0)	
31	Release	GG -> EM	0 - 1	0	Low, (High=0)	
32	Status	GG -> EM	uint16	0	High, Low	
33	RTemp	GG -> EM	sint16	0x7FFF	High, Low	Unit 0.01°C
34	Sum_Sup	GG -> EM	uint16	0	High, Low	Unit l/s
35	Sum_Exh	GG -> EM	uint16	0	High, Low	Unit l/s
36	SystemDevices	GG -> EM	uint16	0	High, Low	no unit
37	ActFire	GG -> EM	0 - 1	0	Low, (High=0)	
38	FanForce	EM -> GG	0 - 1	0	Low, (High=0)	
39	ActFanForce	GG -> EM	0 - 1	0	Low, (High=0)	

## Bit list for X-AIRCONTROL

The Read Coils and Write Single Coil functions are used to access binary data; this is in addition to the above register accesses.

The Write Single Coil function encodes the binary value by (false -> 0x0000, true -> 0x0001) and writes the result to the register.

For bit addresses 0-15 the Read Coils function reads the registers and re-encodes to bit values by using bit 0 of the register values.

Bit addresses 16-22 are copies of the Status register (address 32).

Direction column:

EM -> GG      Reading and writing of bits  
GG -> EM      Reading of bits

Bit address	Useful data register name	Direction EM / GG
-----		
Bits from several registers		
0	StartPCM	EM -> GG
1	Fire	EM -> GG
2	Window	EM -> GG
3	ExtraTime	EM -> GG
4	FanForce	EM -> GG
-----		
8	ActFanForce	GG -> EM
9	ActFire	GG -> EM
10	ActWindow	GG -> EM
11	ActExtraTime	GG -> EM
12	Falarm	GG -> EM
13	Alarm1	GG -> EM
14	Alarm2	GG -> EM
15	Release	GG -> EM
-----		
Bits from Status register		
16	Powersupply	GG -> EM
17	EMFSLIO	GG -> EM
18	FanBlocked	GG -> EM
19	SensorError	GG -> EM
20	FilterAlarm	GG -> EM
21	FlowControl	GG -> EM
22	DamperCalibration	GG -> EM
-----		





**6 Index****A**

Air quality control..... 18

**B**

BACnet MS/TP interface..... 14

Boost..... 19, 27

**C**

Comfort temperature range..... 17, 18, 19, 20, 25

Configuration

BACnet MS/TP interface..... 53

Modbus RTU interface..... 61

Control panel..... 7

Control parameters..... 25, 26

Control temperatures..... 25

Cooling mode..... 25

Copyright..... 3

**D**

Daily schedule..... 27

Data points..... 37

Date ..... 27

Defects liability..... 3

**E**

Electrical installation..... 7

**F**

Fan stages..... 18

Filter operating hours counter

Reset..... 31

Free cooling ..... 20

Free heating..... 20

Frost protection..... 19

FSL-CONNECT

Software..... 22

Functional description..... 16

**H**

Heating mode..... 26

Hotline..... 3

**I**

Interfaces..... 21

**L**

Limitation of liability..... 3

LonWorks interface card..... 14

**M**

Minimum fan stages..... 19

Modbus RTU interface..... 14

**N**

Night purge..... 21, 28

**O**

Occupied..... 18, 27

Operating hours ..... 27

Operating modes..... 18

**P**

Personnel..... 6

**Q**

Qualification..... 6

**R**

Room temperature control..... 17

**S**

Saving energy

Night purge..... 21

Secondary air function..... 19

Service..... 3

Signs..... 5

Software

FSL-CONNECT..... 22

Standby..... 18, 27

Summer/winter compensation..... 19

Supply air temperature..... 25, 26

Symbols..... 5, 23

**T**

Technical service..... 3

Time..... 27

**U**

Unoccupied..... 18, 27



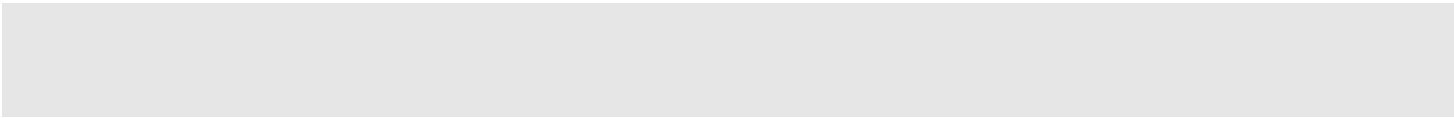

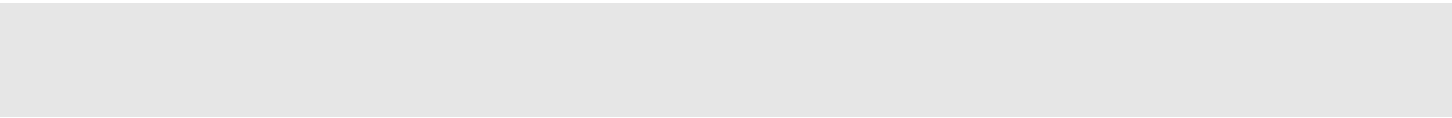

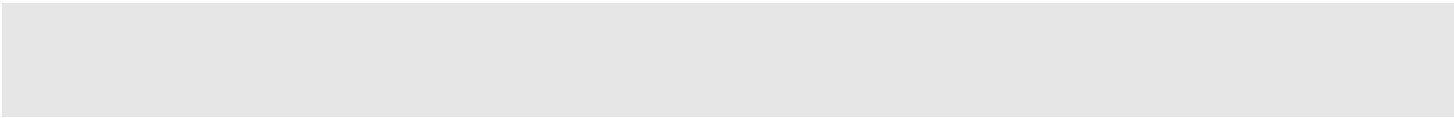

**TROX<sup>®</sup> TECHNIK**

The art of handling air

TROX GmbH  
Heinrich-Trox-Platz  
47504 Neukirchen-Vluyn  
Germany

Phone: +49 (0) 2845 2020  
+49 2845 202-265  
E-mail: [trox@trox.de](mailto:trox@trox.de)  
<http://www.troxtechnik.com>

© TROX GmbH 2017